

# 330 Series Gold Vane High Flow Pump

- Capacities to 700 G.P.M. (158 M<sup>3</sup>/HR)
- Heads to 140 Feet (42 Meters)
- Temperatures to 200°F (93°C)

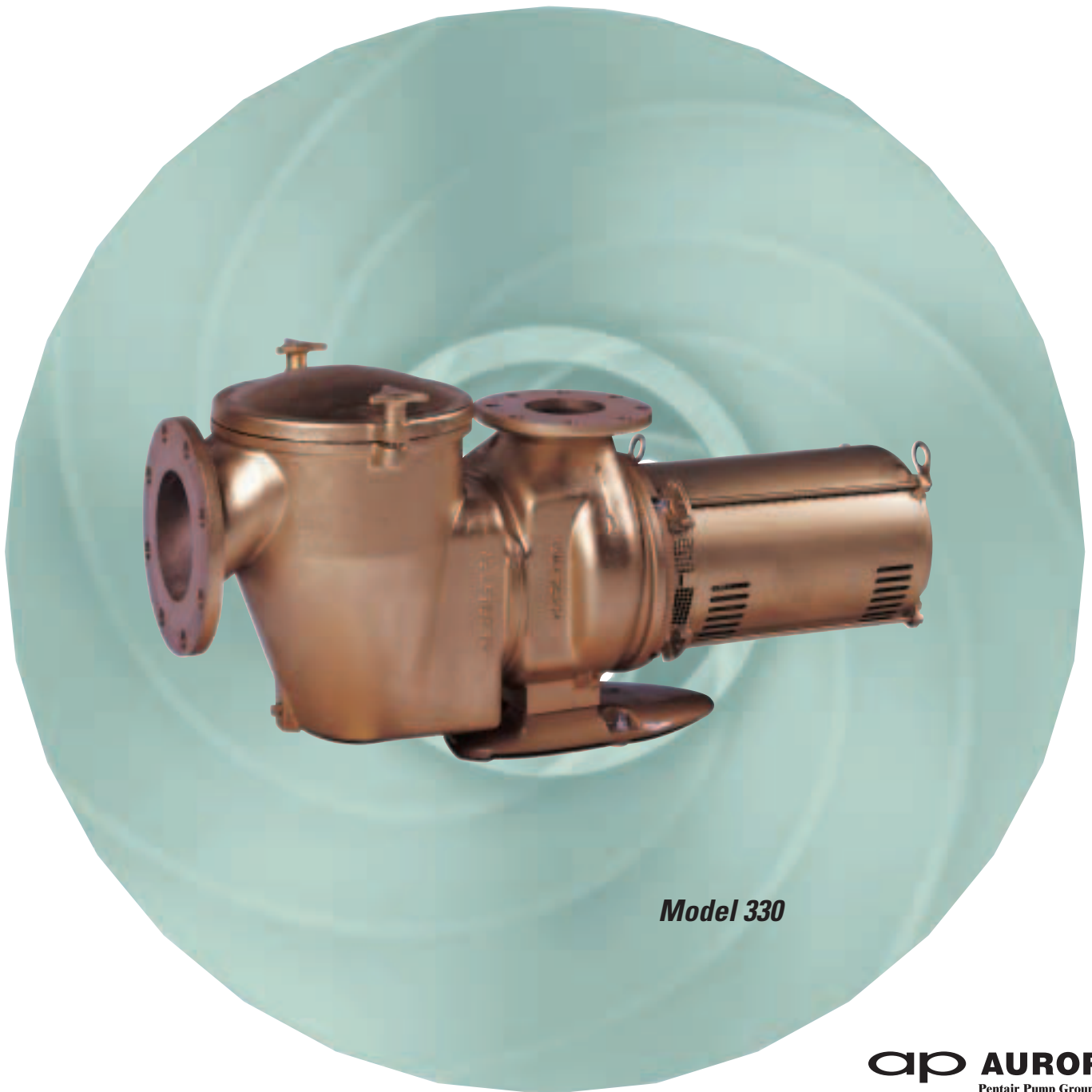

*Model 330*

# Aurora 330 Pump

## Gold Vane High Flow Pump

Aurora's 300 Series heavy duty commercial pump is specifically designed for commercial, public or other large swimming pools, fountains or water where high flow rates and continuous operation are desired. With proven dependability, the Gold Vane pump has set the standard for medium and high-head performance.

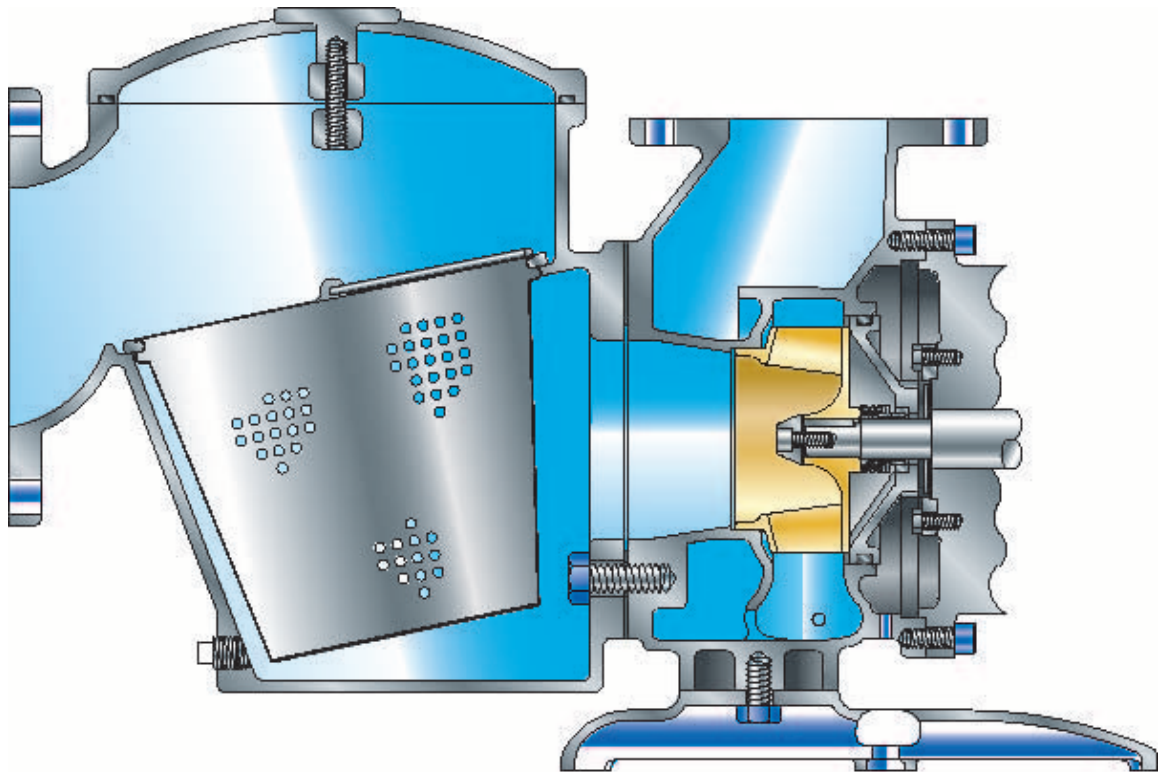

- 1 DURABLE BRASS CONSTRUCTION.
- 2 HIGH PERFORMANCE MOTOR for maximum flow.
- 3 ALL BRONZE CONSTRUCTION for strength and durability.
- 4 6" SUCTION (with strainer pot) or 5" suction (without strainer pot) and 4" discharge for maximum capabilities.
- 5 CLOSED IMPELLER for longer motor bearing life.
- 6 HEAVY-GAUGE STAINLESS STEEL STRAINER BASKET with an open area 14 times the area of the suction port.
- 7 HEAT-RESISTANT SEAL capable of operation up to 220°F.
- 8 AVAILABLE in three phase 50 & 60 cycle models and single phase 60 cycle models.
- 9 ONE YEAR LIMITED WARRANTY.

# 330 Curves

3450 RPM

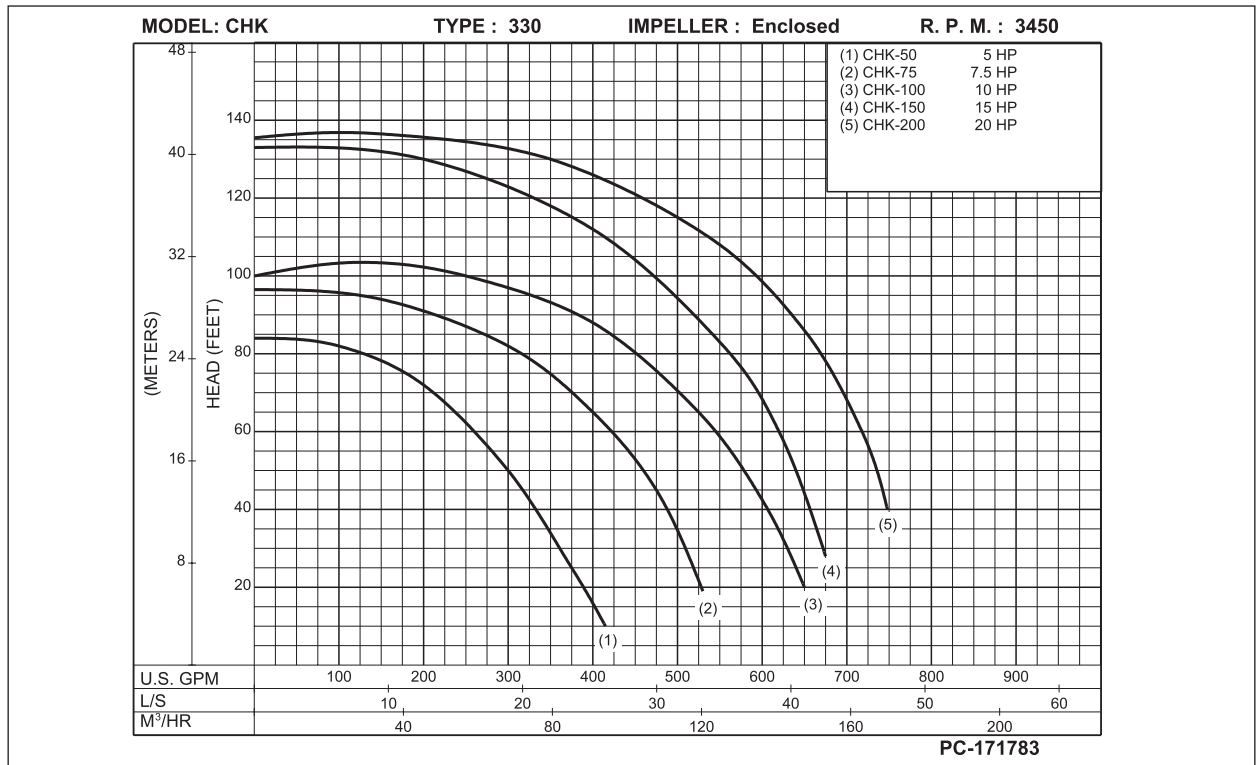

3450 RPM

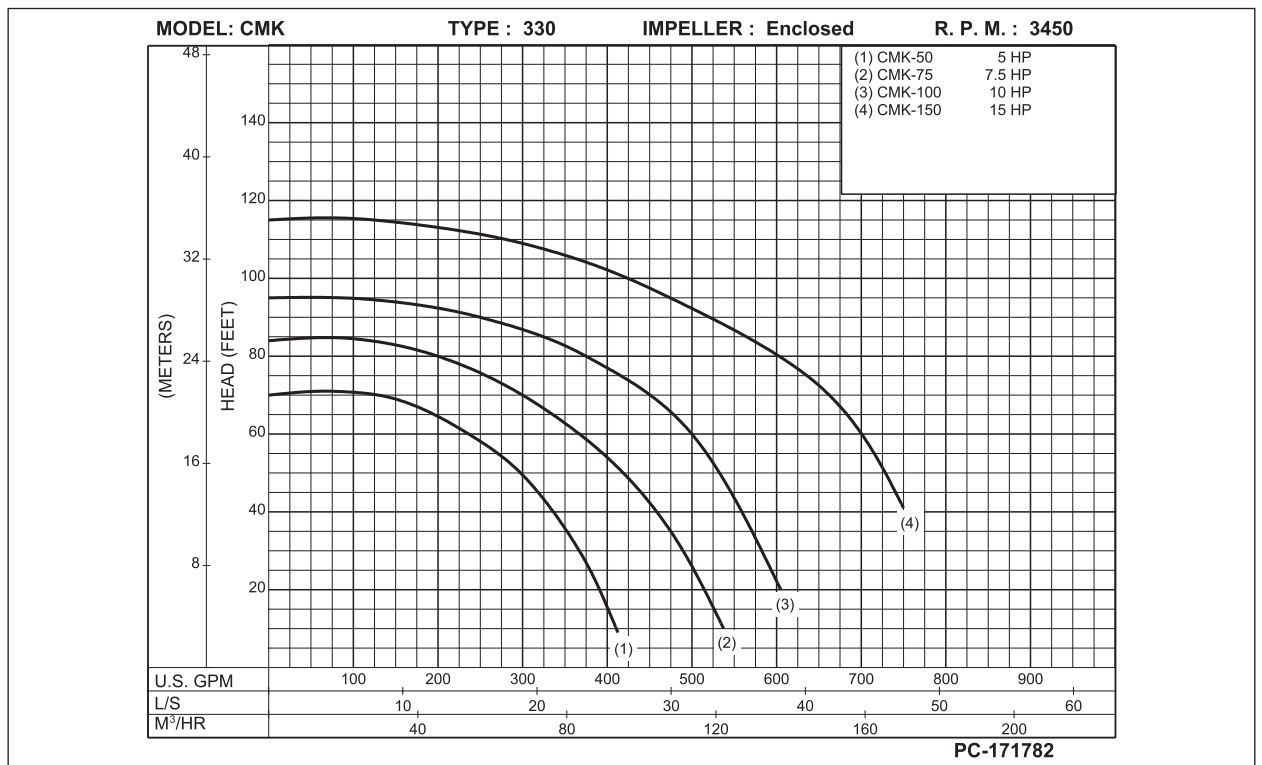

# 330 Curves

2850 RPM

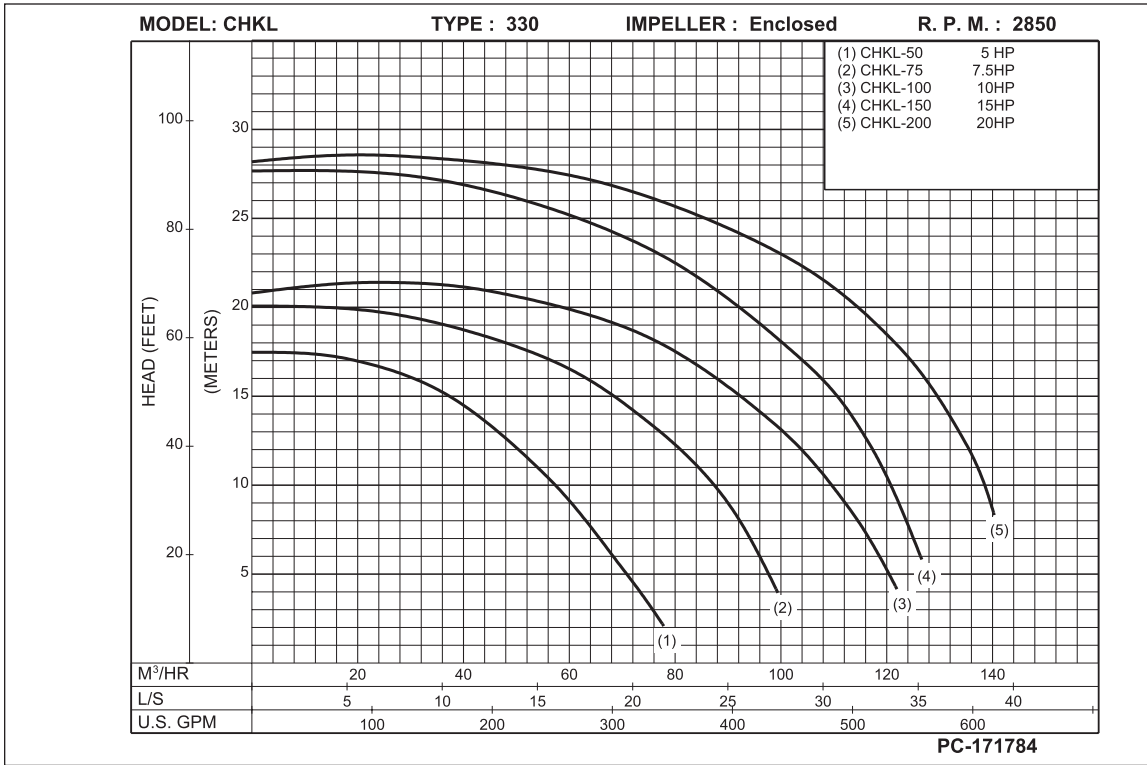

2850 RPM

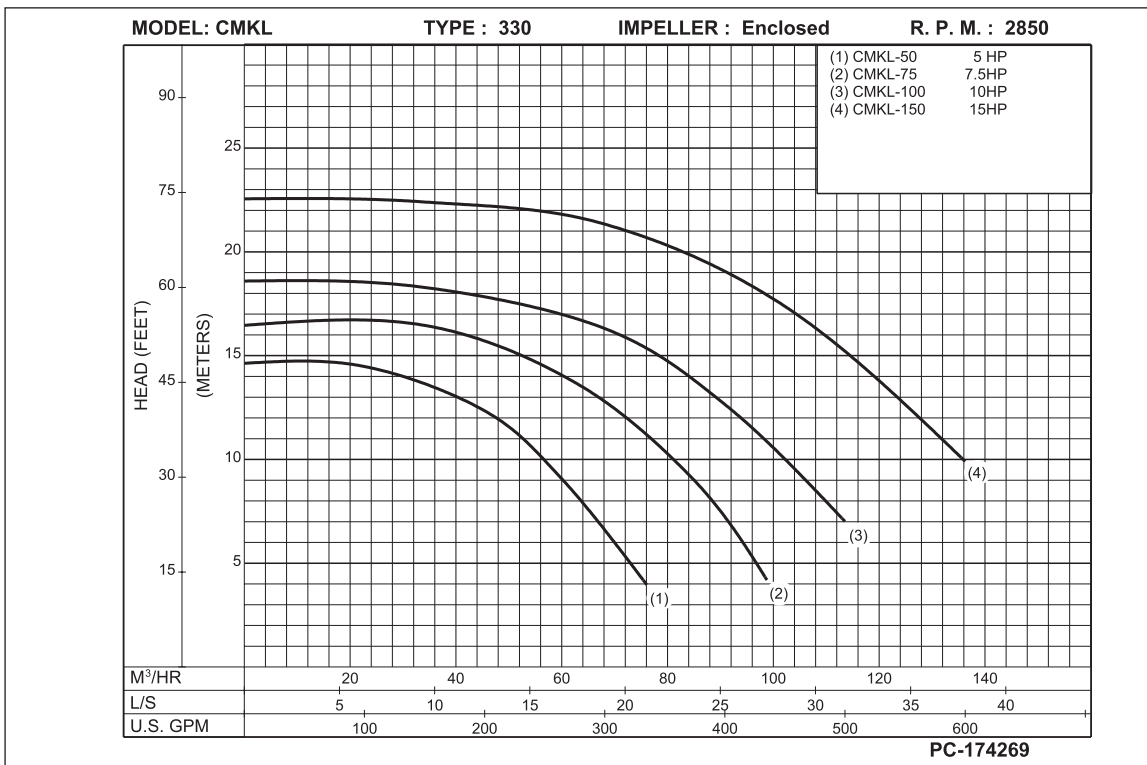

# 330 Product Offering

## 1 PHASE 200-208 VOLT WITH HAIR/LINT POT

Aurora No.	Model	Head	HP	Wt. lbs (kg)
A347939	CH-50	High	5	352 (160)
A347938	CM-50	Medium	5	352 (160)
A348005	CH-75	High	7.5	362 (164)
A348001	CM-75	Medium	7.5	362 (164)

## 3 PHASE 200-208 VOLT WITH HAIR/LINT POT

Aurora No.	Model	Head	HP	Wt. lbs (kg)
A347941	CHK-50	High	5	336 (152)
A347940	CMK-50	Medium	5	336 (152)
A347943	CHK-75	High	7.5	346 (157)
A347942	CMK-75	Medium	7.5	346 (157)
A347945	CHK-100	High	10	376 (171)
A347944	CMK-100	Medium	10	374 (170)
A347947	CHK-150	High	15	398 (181)
A347946	CMK-150	Medium	15	396 (180)
A347948	CHK-200	High	20	474 (215)

## 3 PHASE 220-440 VOLT WITH HAIR/LINT POT

Aurora No.	Model	Head	HP	Wt. lbs (kg)
A011657	CHK-50	High	5	336 (152)
A011652	CMK-50	Medium	5	336 (152)
A011658	CHK-75	High	7.5	346 (157)
A011653	CMK-75	Medium	7.5	346 (157)
A011659	CHK-100	High	10	376 (171)
A011654	CMK-100	Medium	10	374 (170)
A011660	CHK-150	High	15	398 (181)
A011655	CMK-150	Medium	15	396 (180)
A011661	CHK-200	High	20	474 (215)

## 1 PHASE 200-208 VOLT WITHOUT HAIR/LINT POT

Aurora No.	Model	Head	HP	Wt. lbs (kg)
A347950	CH-50	High	5	302 (137)
A347949	CM-50	Medium	5	302 (137)
A347961	CH-75	High	7.5	312 (142)
A347960	CM-75	Medium	7.5	310 (141)

## 3 PHASE 200-208 VOLT WITHOUT HAIR/LINT POT

Aurora No.	Model	Head	HP	Wt. lbs (kg)
A347952	CHK-50	High	5	286 (130)
A347951	CMK-50	Medium	5	286 (130)
A347954	CHK-75	High	7.5	299 (136)
A347953	CMK-75	Medium	7.5	296 (136)
A347956	CHK-100	High	10	326 (148)
A347955	CMK-100	Medium	10	324 (147)
A347958	CHK-150	High	15	348 (158)
A347957	CMK-150	Medium	15	346 (157)
A347959	CHK-200	High	20	424 (192)

## 3 PHASE 220-440 VOLT WITHOUT HAIR/LINT POT

Aurora No.	Model	Head	HP	Wt. lbs (kg)
A011606	CHK-50	High	5	286 (130)
A011601	CMK-50	Medium	5	286 (130)
A011607	CHK-75	High	7.5	299 (136)
A011602	CMK-75	Medium	7.5	296 (136)
A011608	CHK-100	High	10	326 (148)
A011603	CMK-100	Medium	10	324 (147)
A011609	CHK-150	High	15	348 (158)
A011604	CMK-150	Medium	15	346 (157)
A011610	CHK-200	High	20	424 (192)

## 1 PHASE 230 VOLT WITH HAIR/LINT POT

Aurora No.	Model	Head	HP	Wt. lbs (kg)
A011656	CH-50	High	5	352 (160)
A011651	CM-50	Medium	5	352 (160)
A347916	CH-75	High	7.5	362 (164)
A347917	CM-75	Medium	7.5	362 (164)

## 3 PHASE 380-415 VOLT WITH HAIR/LINT POT

Aurora No.	Model	Head	HP	Wt. lbs (kg)
A014880	CHKL-50	High	5	336 (152)
A014900	CMKL-50	Medium	5	336 (152)
A014881	CHKL-75	High	7.5	346 (157)
A014901	CMKL-75	Medium	7.5	346 (157)
A014882	CHKL-100	High	10	374 (170)
A014902	CMKL-100	Medium	10	376 (171)
A014883*	CHKL-150	High	15	396 (180)
A014903*	CMKL-150	Medium	15	398 (181)
A014884*	CHKL-200	High	20	474 (215)

## 3 PHASE 575 VOLT WITH HAIR/LINT POT

Aurora No.	Model	Head	HP	Wt. lbs (kg)
A347931*♦	CMK-50	Medium	5	336 (152)
A347937	CHK-75	High	7.5	346 (157)
A347936	CMK-75	Medium	7.5	346 (157)
A347932*♦	CMK-100	Medium	10	374 (170)
A347933	CHK-150	High	15	398 (181)
A347934	CMK-150	Medium	15	396 (180)
A347935	CHK-200	High	20	474 (215)

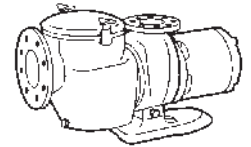

## 1 PHASE 230 VOLT WITHOUT HAIR/LINT POT

Aurora No.	Model	Head	HP	Wt. lbs (kg)
A011605	CH-50	High	5	302 (137)
A011600	CM-50	Medium	5	302 (137)
A348006♦	CH-75	High	7.5	312 (142)
A348007♦	CM-75	Medium	7.5	310 (141)

## 3 PHASE 380-415 VOLT WITH HAIR/LINT POT

Aurora No.	Model	Head	HP	Wt. lbs (kg)
A015880♦	CHKL-50	High	5	286 (130)
A016900♦	CMKL-50	Medium	5	286 (130)
A015881♦	CHKL-75	High	7.5	296 (136)
A016901♦	CMKL-75	Medium	7.5	299 (136)
A015882♦	CHKL-100	High	10	324 (147)
A016902♦	CMKL-100	Medium	10	326 (148)
A015883*♦	CHKL-150	High	15	346 (157)
A016903*♦	CMKL-150	Medium	15	348 (158)
A015884*♦	CHKL-200	High	20	424 (192)

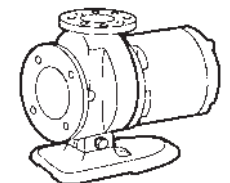

\* SUITABLE FOR WYE-DELTA START  
♦ PUMP NOT NSF APPROVED

# 330 Dimensions

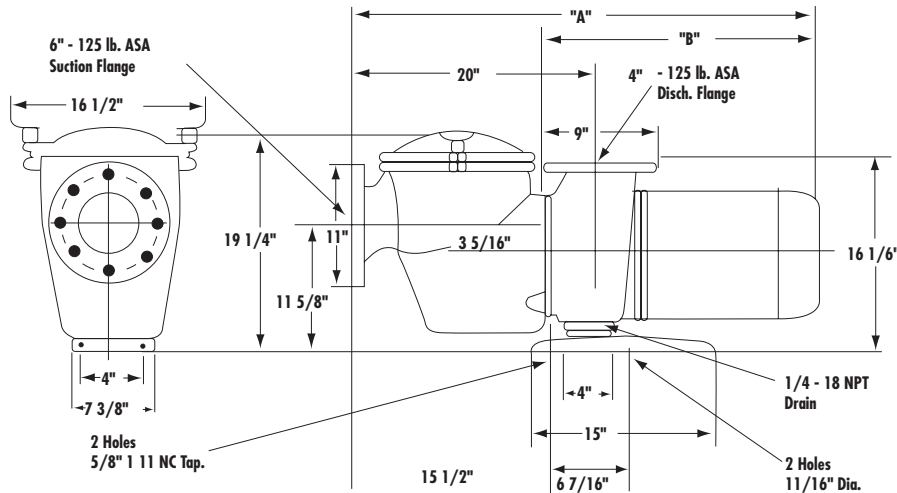

Pump Dimensions			
Three-Phase Amps @ 220/440 & 380/415			
HP	AMPS	A	B
5	14	36 (914)	19-1/2 (495)
7.5	20	36 (914)	20-1/2 (520)
10	26	39 (991)	22-1/2 (571)
15	38	39 (991)	22 (558)
20	46	40 (1016)	23-1/2 (596)
Single-Phase Amps @230V			
5	26	36 (914)	20-1/2 (520)
7.5	37	37 (940)	20-1/2 (520)
Single-Phase Amps @200V			
5	29	36 (914)	20-1/2 (520)
7.5	39.6	37 (940)	20-1/2 (520)

**NOTES:**

1. Dimensions and weights are approximate.
2. All dimensions are in inches (mm) and may vary ± 1/4 (6).

## Engineering Specifications

### Engineering Specifications

The contractor shall furnish (and install in location as shown on the plan) an Aurora Type 330, all bronze construction centrifugal pump. Each pump shall have a capacity of ... GPM at ... ft. total head and specific gravity. The pump is to be furnished with an enamel coated cast iron foot, a mechanical seal with all metal parts to be stainless steel, O-Rings made of "Buna-N" Elastomer, ceramic seat, and carbon washer.

### Materials of Construction

Volute Casing	Bronze CA 84400
Impeller	Bronze CA 83600
Strainer Pot	Bronze CA 84400
Cover	Bronze CA 83450
Strainer	Stainless Steel
Pump Shaft	Stainless Steel
Mechanical Seal	300 Stainless Steel metal parts, Buna-N elastomers, Ceramic Seat and Carbon Washer
O-Rings	"Buna-N" Elastomer
Gasket	Cellulose w/Nitrile
Pump Foot	Enamel Coated Cast Iron CL 30

**NOTE:** Aurora Pump reserves the right to make revisions to its products and their specifications, and to this bulletin and related information, without notice.

— Your Authorized Local Distributor —



**MARKETING & SALES:**  
 800 AIRPORT ROAD • NORTH AURORA, ILLINOIS U.S.A. • 60542  
 PHONE: (630) 859-7000 U.S.A./CANADA FAX: (630) 859-7060  
 WORLDWIDE FAX: (630) 859-1226  
**WEB:** www.aurorapump.com  
**EMAIL:** aurora\_info@pentairpump.com

**AURORA MFG. PLANT:**  
 800 AIRPORT ROAD • NORTH AURORA, ILLINOIS U.S.A. • 60542

**SALES OFFICES IN ALL MAJOR CITIES AND COUNTRIES**  
 Refer to "Pumps" in yellow pages of your phone directory for your local Distributor.

