

Performance Curves for the 410 Series (50 Hz)

MODEL/SIZE	R.P.M.	PDF PAGE
2x2-1/2x9	2880	3
2x2-1/2x9	1440	4
2x2-1/2x10	2880	5
2x2-1/2x10	1440	6
2x2-1/2x12	1440	7
2x2-1/2x12	960	8
2-1/2x3x10B	2880	9
2-1/2x3x10B	1440	10
2-1/2x3x12	1440	11
2-1/2x3x12	960	12
3x4x10B	2880	13
3x4x10B	1440	14
3x4x10C	2950	15
3x4x10C	1440	16
3x4x14	1440	17
3x4x14	960	18
4x5x10B	2880	19
4x5x10B	1440	20
4x5x11A	1440	21
4x5x11A	960	22
4x5x11C	2950	23
4x5x11C	1440	24
4x5x15	1440	25
4x5x15	960	26
4x6x18B	1475	27
4x6x18B	960	28
5x6x11A	1440	29
5x6x11A	960	30
5x6x11C	2950	31
5x6x11C	1440	32
5x6x15	1440	33
5x6x15	960	34
5x6x17	1475	35
5x6x17	960	36
6x8x11	1440	37
6x8x11	960	38
6x8x15	1475	39
6x8x15	960	40
6x8x18A	1475	41
6x8x18A	980	42
6x8x18B	1475	43
6x8x18B	960	44
6x8x18C	1475	45

Continued next page

Performance Curves for the 410 Series (50 Hz) (cont.)

MODEL/SIZE	R.P.M.	PDF PAGE
6x8x18C	960	46
6x8x20	1475	47
8x8x11B	1440	48
8x8x11B	960	49
8x10x12	1440	50
8x10x12	960	51
8x10x12A	1475	52
8x10x12A	980	53
8x10x15A	1475	54
8x10x15A	960	55
8x10x21	1475	56
8x10x21	980	57
8x10x21A	1475	58
8x10x21A	980	59
10x12x12B	1440	60
10x12x12B	980	61
10x12x15B	1475	62
10x12x15B	980	63
10x12x15C	1475	64
10x12x15C	980	65
10x12x18	1475	66
10x12x18	980	67
12x14x15B	1475	68
12x14x15B	980	69
12x14x18A	1475	70
12x14x18A	980	71
14x16x18	980	72
14x16x18	735	73

SIZE: 2X2 1/2X9 TYPE: 410 IMPELLER: ENCLOSED R.P.M.: 2880

MAX. SPHERES 3 mm
IMP. PATT. NO. 444A320
CASE PATT. NO.
180A015 UPPER (ALL)
180A016 LOWER (411)
180A068 LOWER (412 & 413)
MIN. IMP. DIA. 152 mm

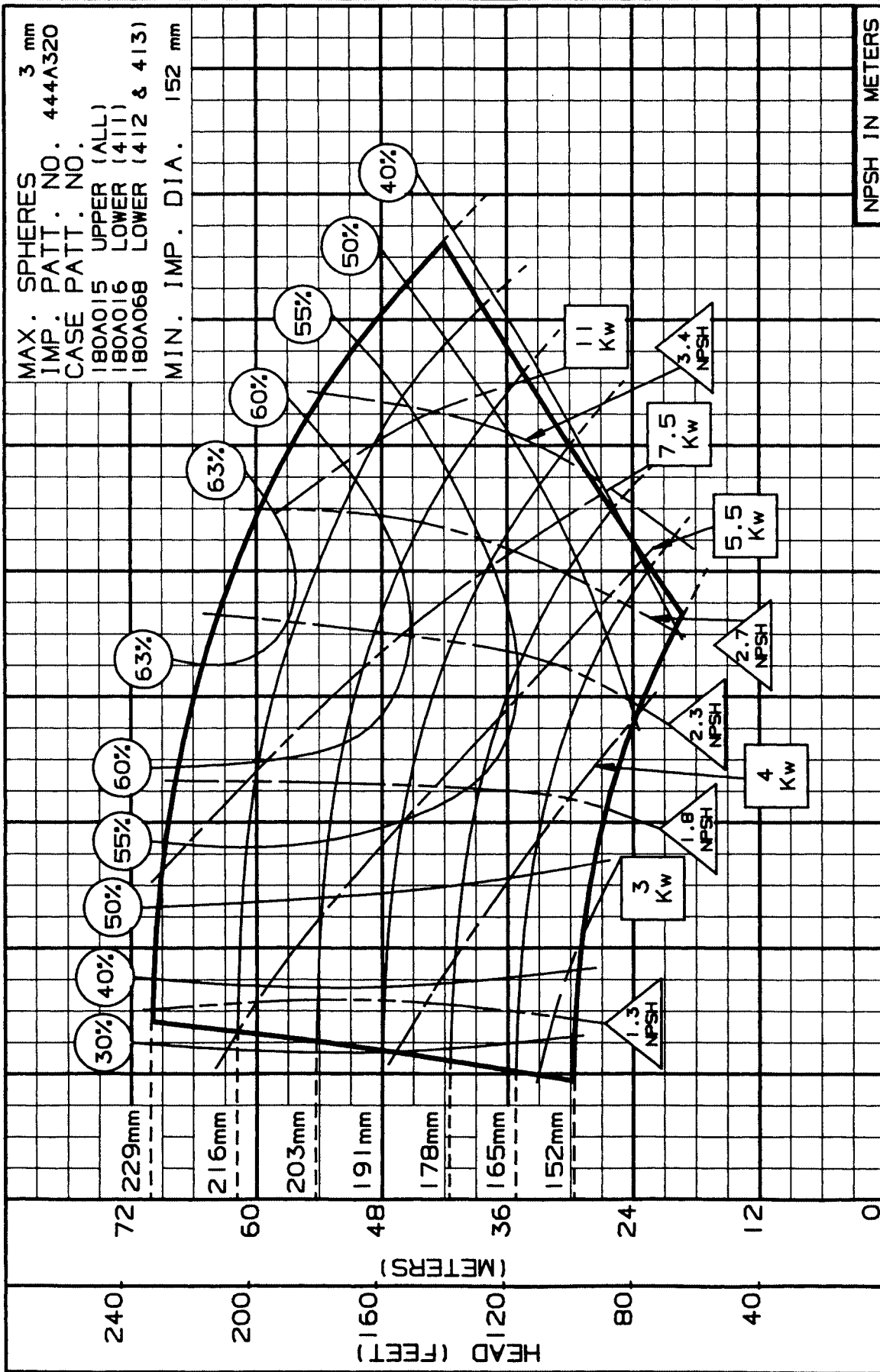

M ³ /HR	0	8	16	24	32	40	48	56	64	72
L/S	0	4	8	12	16	20	24	28	32	36
U.S. GPM	0	40	80	120	160	200	240	280	320	360
NPSH IN METERS										

DRAWN BY: *RAL* APPROVED BY: DL DATE: 7-90 PC-117351M

2x2-1/2x9 - 1440 RPM
 ENCLOSED IMPELLER

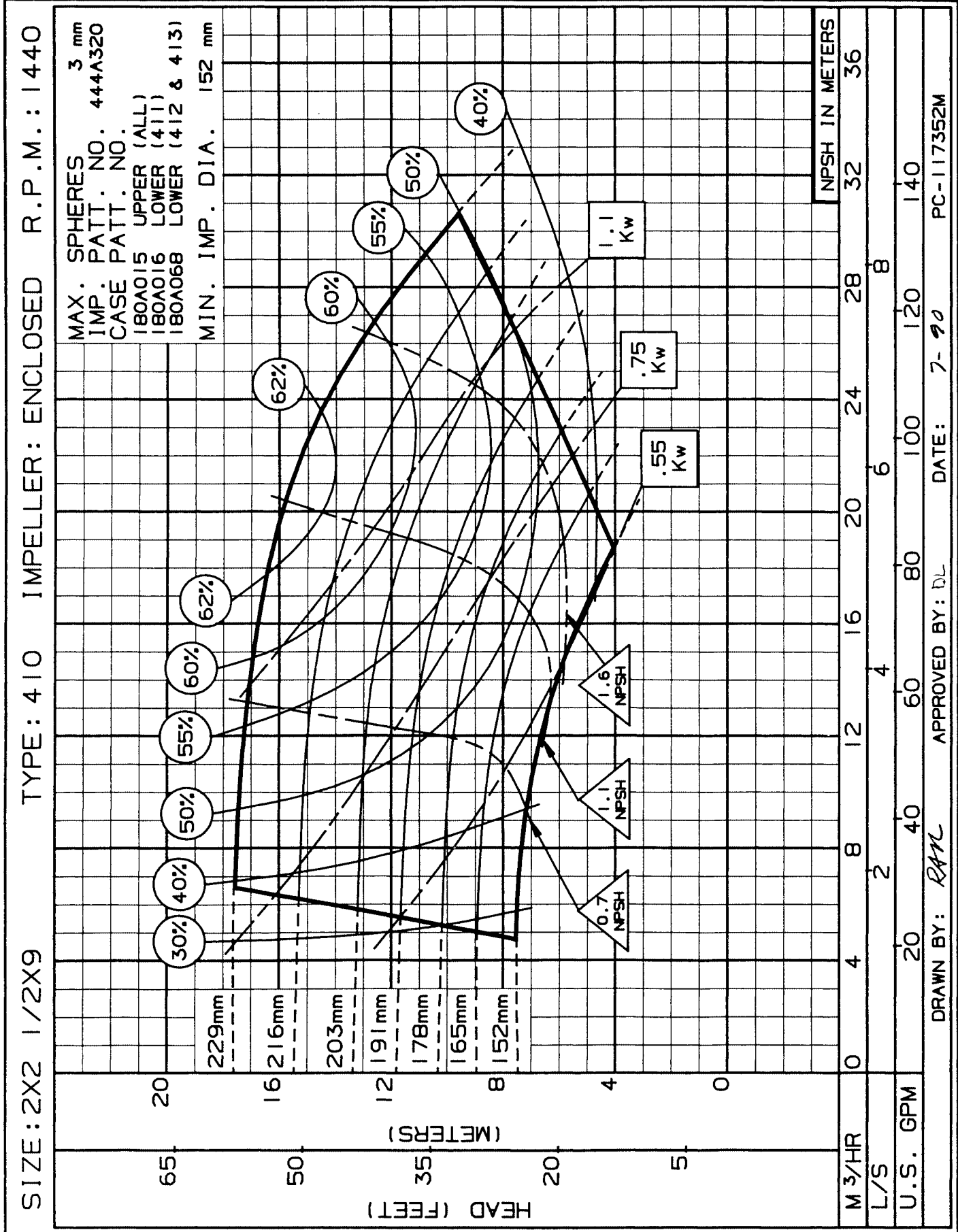

SIZE: 2X2 1/2X10 TYPE: 410 IMPELLER: ENCLOSED R.P.M.: 2880

MAX. SPHERES 6 mm
IMP. PATT. NO. 444A321
CASE PATT. NO.
180A017 UPPER (ALL)
180A018 LOWER (411)
180A069 LOWER (412 & 413)
MIN. IMP. DIA. 165 mm

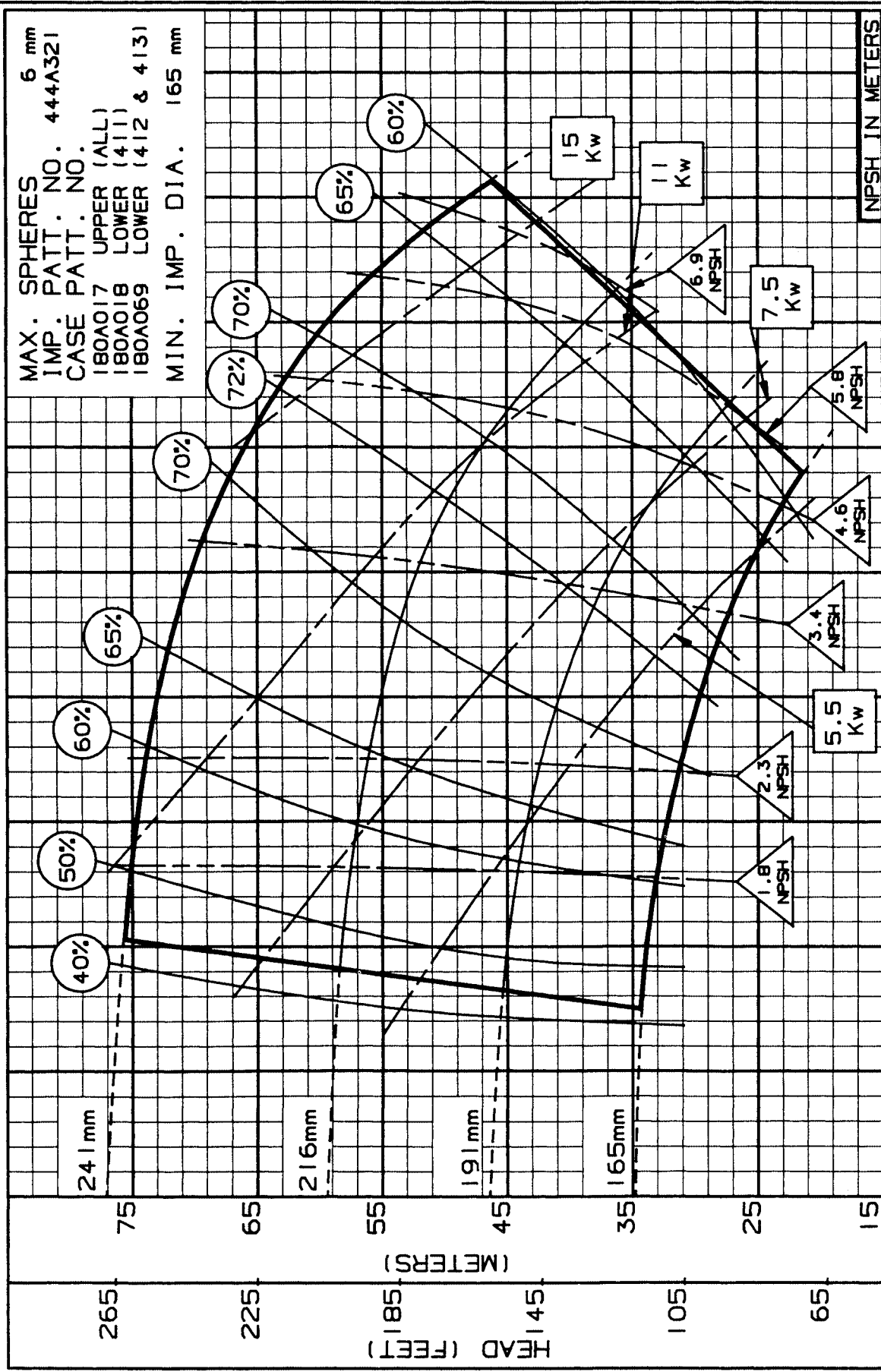

M ³ /HR	0	10	20	30	40	50	60	70	80	90
L/S	4	8	12	16	20	24	28	32	36	40
U.S. GPM	50	100	150	200	250	300	350	400	450	500

DRAWN BY: *ATC* APPROVED BY: *DL* DATE: 7-90 PC-117353M

SECTION 410 (Metric 50Hz)
 DATE JULY 1994
 SUPERCEDES MARCH 1986

2x2-1/2x10 - 1440 RPM
 ENCLOSED IMPELLER



SIZE: 2X2 1/2X10 TYPE: 410 IMPELLER: ENCLOSED R.P.M.: 1440

MAX. SPHERES 6 mm
 IMP. PATT. NO. 444A321
 CASE PATT. NO.
 180A017 UPPER (ALL)
 180A018 LOWER (411)
 180A069 LOWER (412 & 413)
 MIN. IMP. DIA. 165 mm

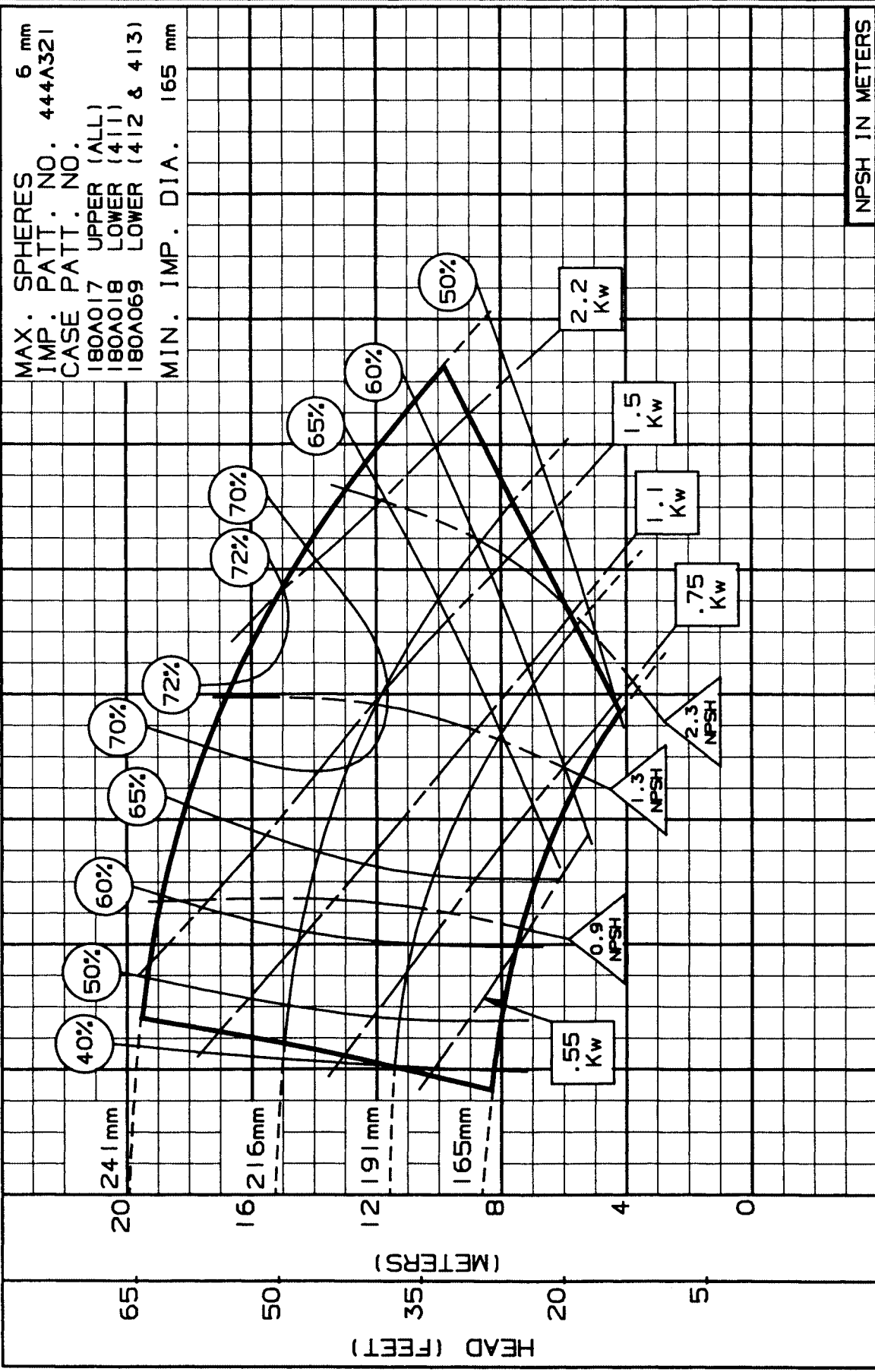

M ³ /HR	0	8	16	24	32	40	48	56	64	72
L/S	4	8	12	16	20	24	28	32	36	40
U.S. GPM	40	80	120	160	200	240	280	320	360	400
DRAWN BY: <i>ATL</i> APPROVED BY: <i>DL</i> DATE: 7-90 PC-117354M										

SIZE: 2X2 1/2X12 TYPE: 410 IMPELLER: ENCLOSED R.P.M.: 1440

MAX. SPHERES 6 mm
IMP. PATT. NO. 444A322
CASE PATT. NO.
180A019 UPPER (ALL)
180A020 LOWER (411)
180A070 LOWER (412 & 413)
MIN. IMP. DIA. 229 mm

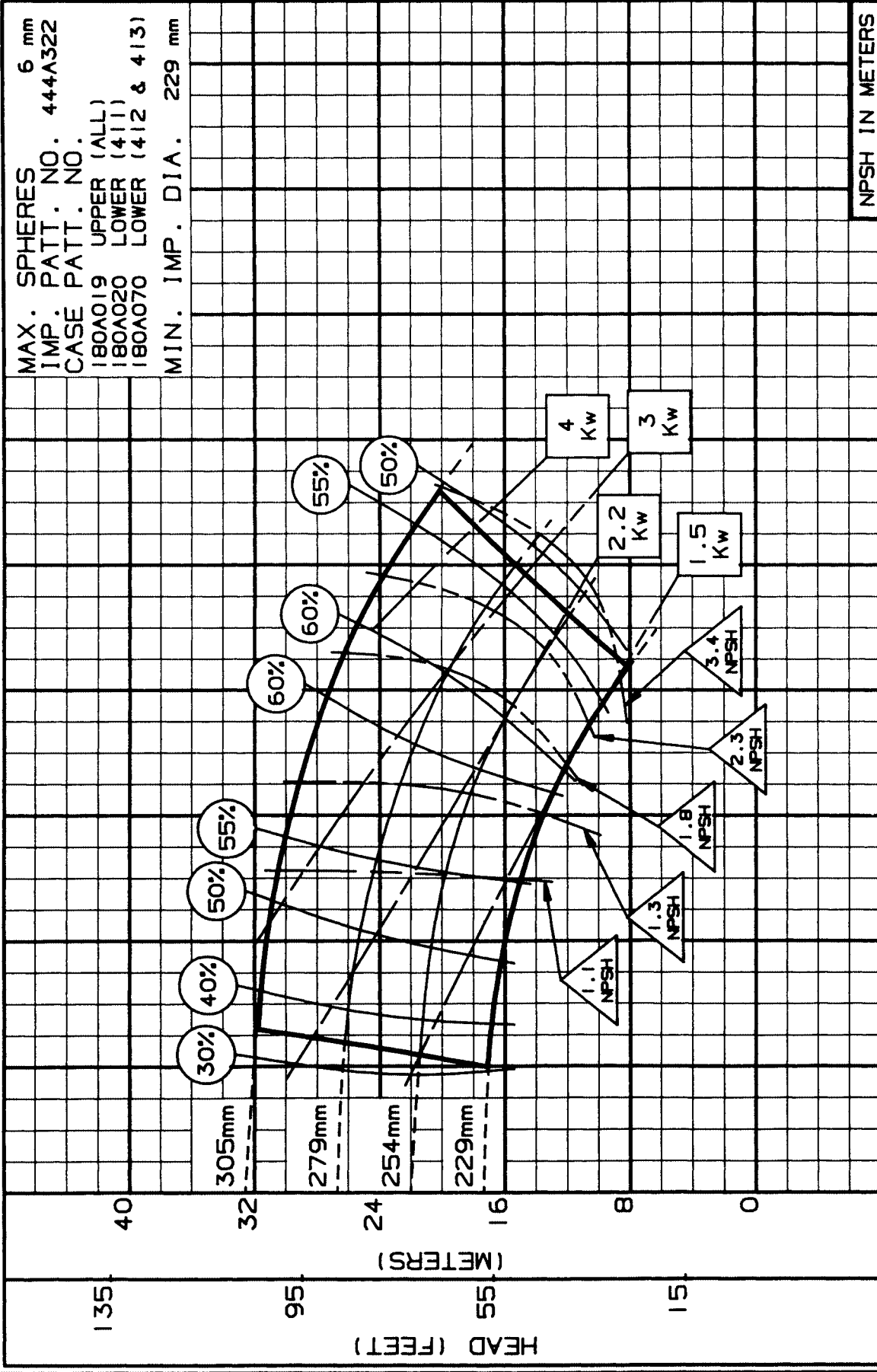

M ³ /HR	0	8	16	24	32	40	48	56	64	72
L/S	0	4	8	12	16	20	24	28	32	36
U.S. GPM	0	40	80	120	160	200	240	280	320	360
NPSH IN METERS										
PC-117355M										

DRAWN BY: *R. J. L.* APPROVED BY: DL DATE: 7-90

SECTION 410 (Metric 50Hz)
 DATE JULY 1994
 SUPERCEDES MARCH 1986

2x2-1/2x12 - 960 RPM
 ENCLOSED IMPELLER

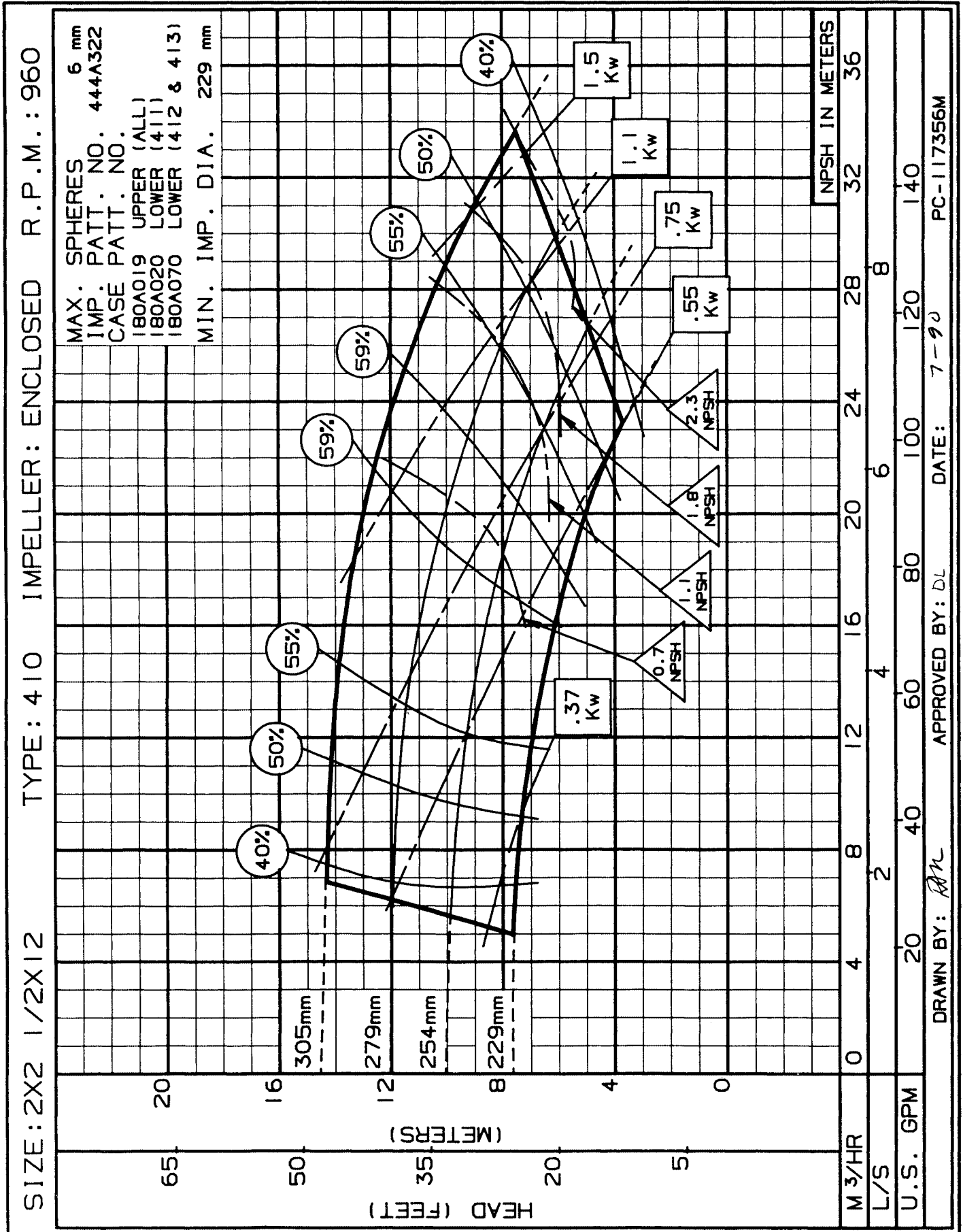

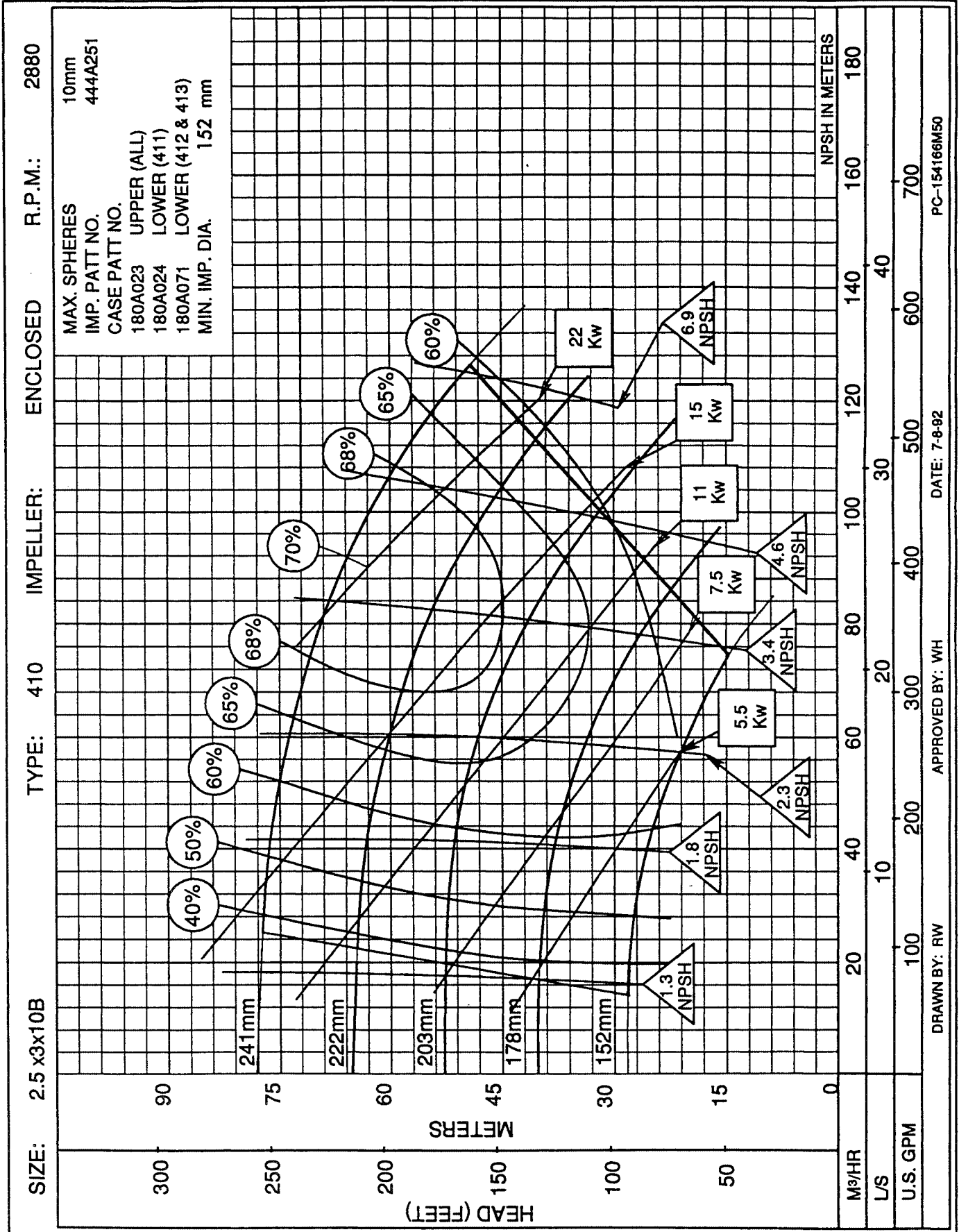

PC-154166M50

DATE: 7-8-92

APPROVED BY: WH

DRAWN BY: RW

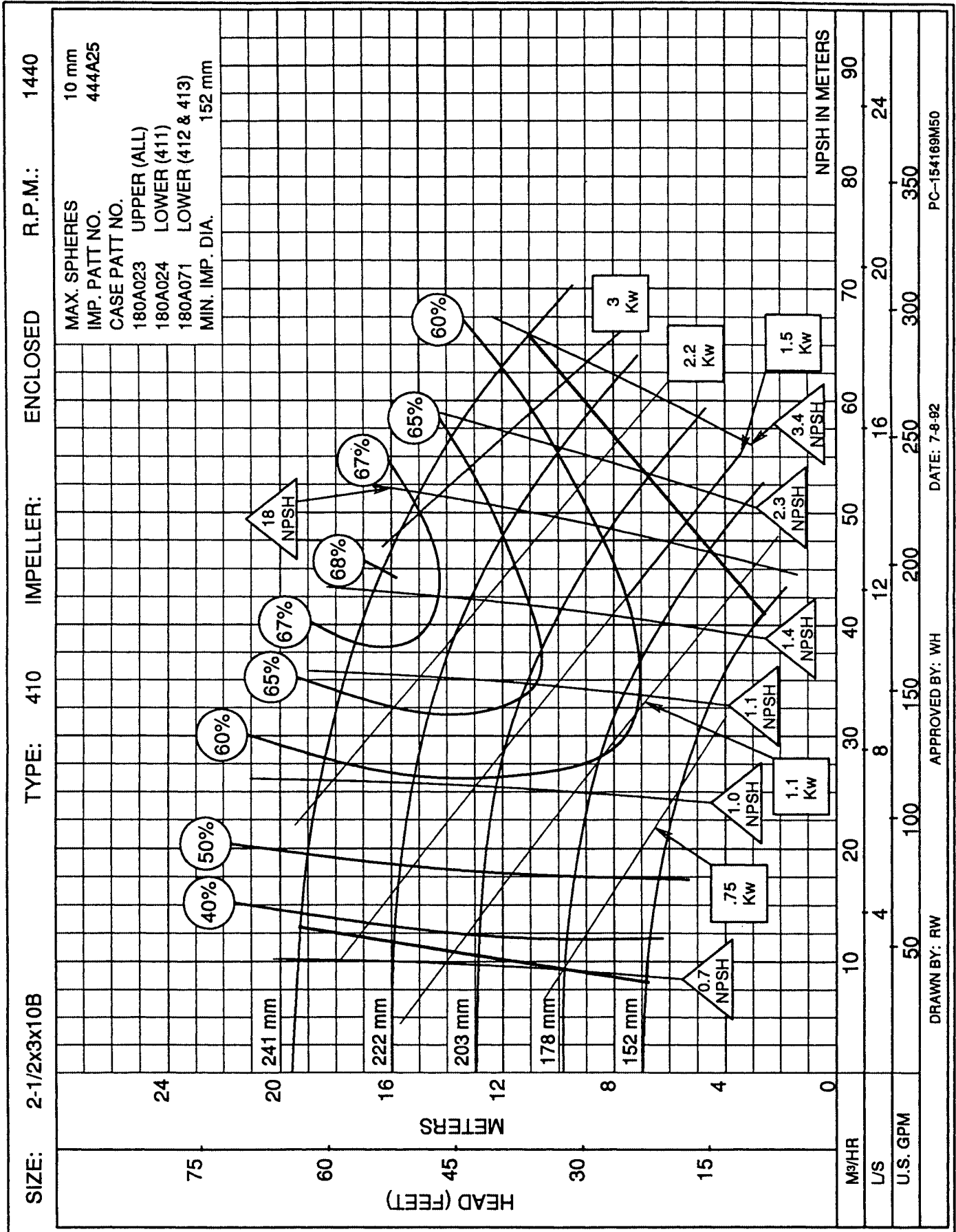

DRAWN BY: RW

APPROVED BY: WH

DATE: 7-8-92

PC-154169M50

SIZE: 2 1/2x3x12 TYPE: 410 IMPELLER: ENCLOSED R.P.M.: 1440

MAX. SPHERES 10 mm
IMP. PATT. NO. 444A323
CASE PATT. NO.
180A025 UPPER (ALL)
180A025 LOWER (411)
180A072 LOWER (412 & 413)
MIN. IMP. DIA. 229 mm

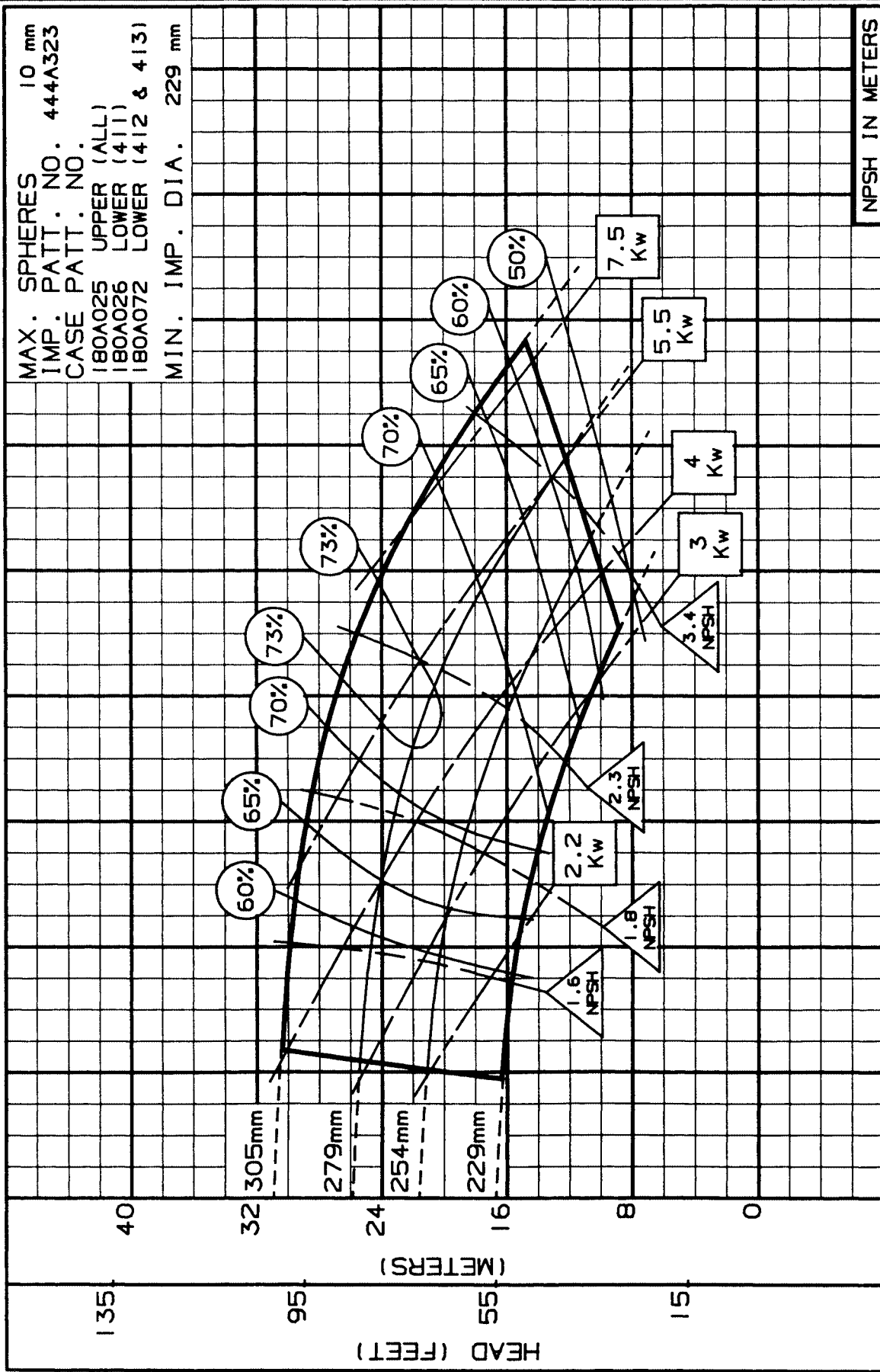

M ³ /HR	0	16	32	48	64	80	96	112	128	144
L/S	5	10	15	20	25	30	35	40	45	50
U.S. GPM	75	150	225	300	375	450	525	600	675	750
NPSH IN METERS										

DRAWN BY: *BA/C* APPROVED BY: DL DATE: 7-90 PC-117359M

2-1/2X3x12 - 960 RPM
 ENCLOSED IMPELLER



SIZE: 2 1/2X3X12 TYPE: 410 IMPELLER: ENCLOSED R.P.M.: 960

MAX. SPHERES 10 mm
 IMP. PATT. NO. 444A323
 CASE PATT. NO.
 180A025 UPPER (ALL)
 180A026 LOWER (411)
 180A072 LOWER (412 & 413)
 MIN. IMP. DIA. 229 mm

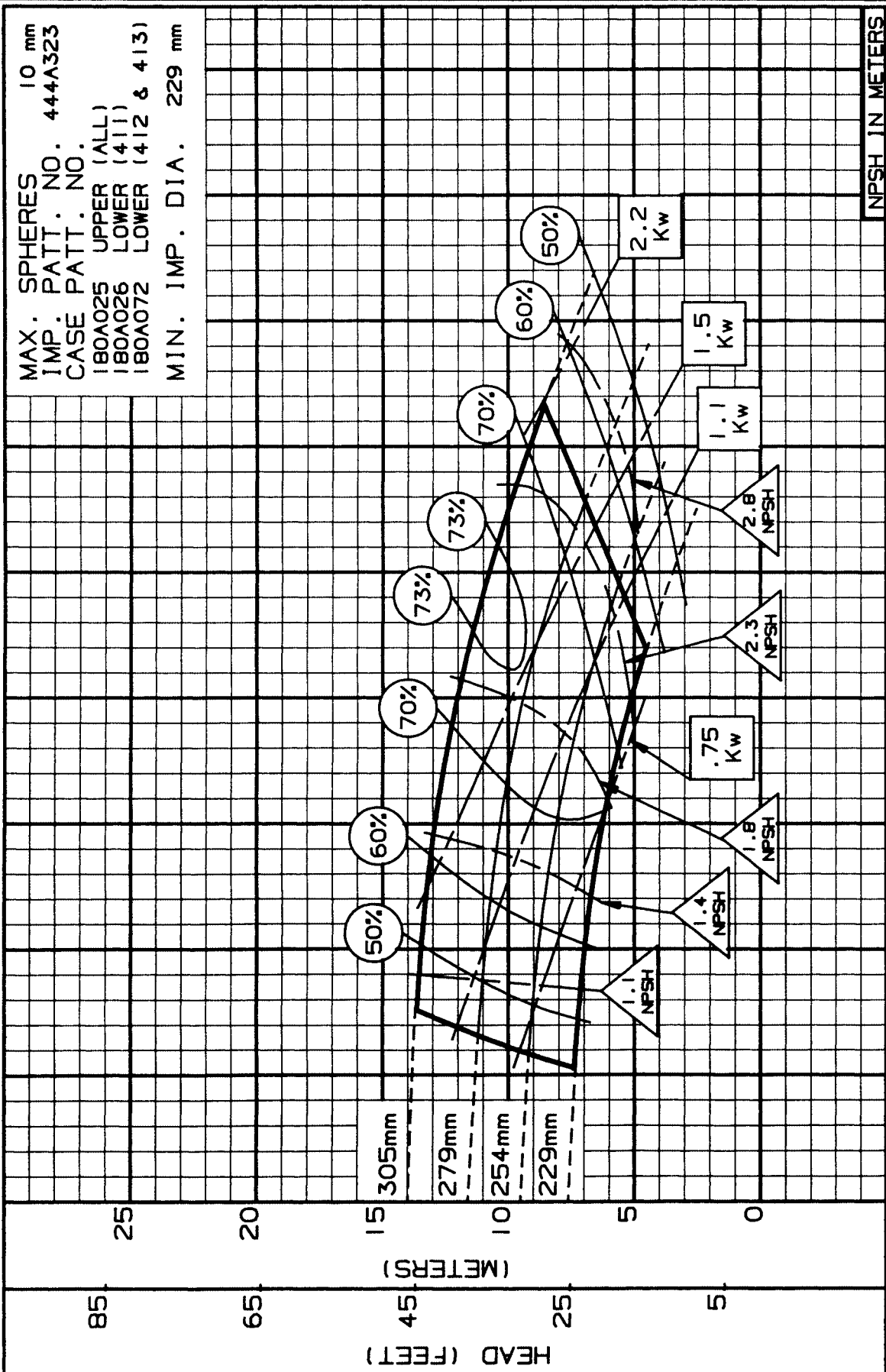

M ³ /HR	0	10	20	30	40	50	60	70	80	90
L/S	0	4	8	12	16	20	24	28	32	36
U.S. GPM	0	50	100	150	200	250	300	350	400	450

DRAWN BY: *ABC* APPROVED BY: DL DATE: 7-9-94 PC-117360M

SIZE: 3X4X10B TYPE: 410 IMPELLER: ENCLOSED R.P.M.: 2880

MAX. SPHERES 13 mm
IMP. PATT. NO. 444A131
CASE PATT. NO.
180A027 UPPER (ALL)
180A028 LOWER (411)
180A023 LOWER (412 & 413)
MIN. IMP. DIA. 152 mm

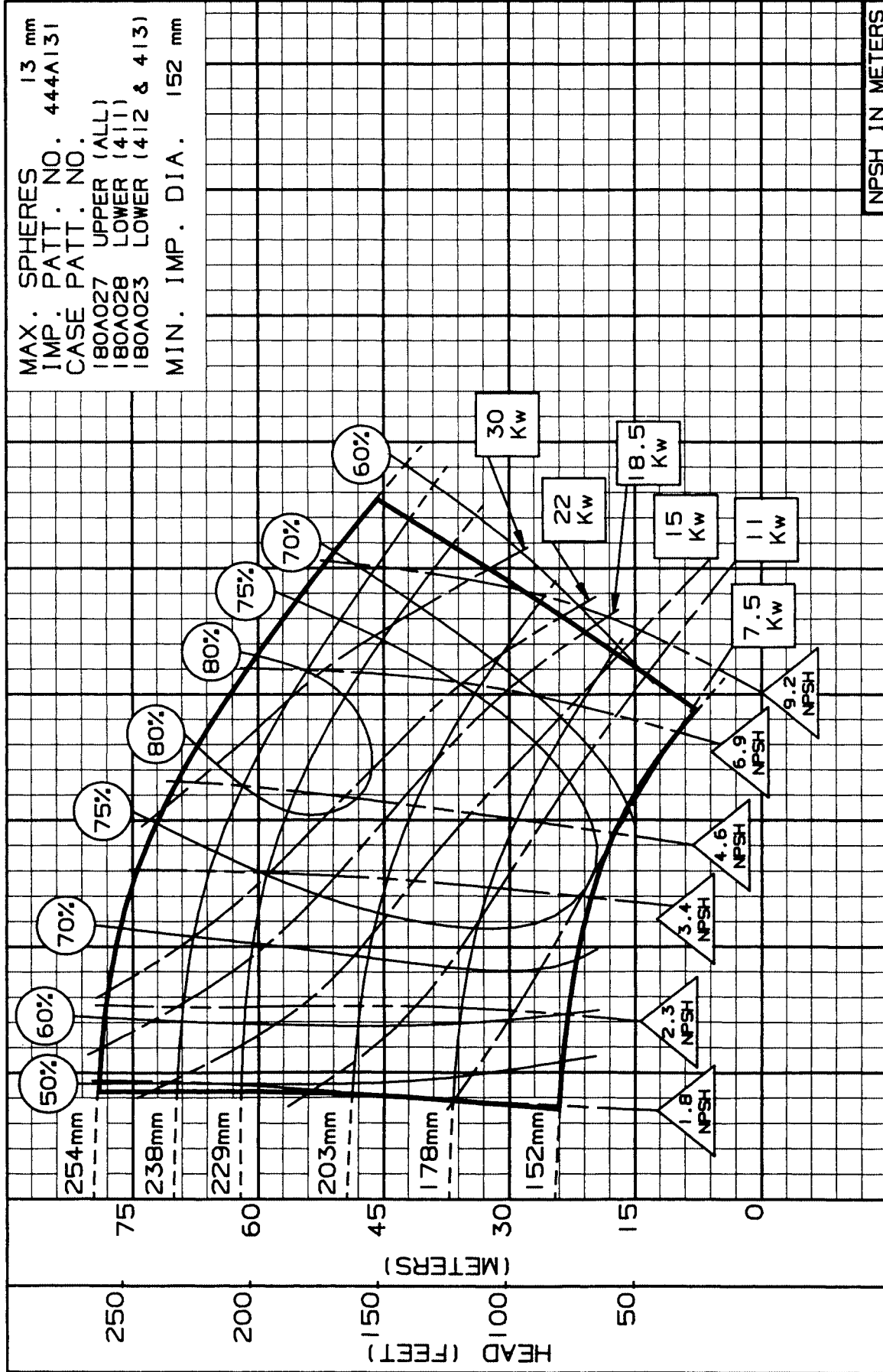

HEAD (FEET)	250	200	150	100	50	0				
HEAD (METERS)	75	60	45	30	15	0				
U.S. GPM	200	400	600	800	1000	1200	1400			
L/S	15	30	45	60	75	90	100			
M ³ /HR	0	40	80	120	160	200	240	280	320	360
NPSH IN METERS										

DRAWN BY: *AKC* APPROVED BY: DL DATE: 7-90 PC-124752M

SECTION 410 (Metric 50Hz)
 DATE JULY 1994
 SUPERCEDES MARCH 1986

3x4x10B - 1440 RPM
 ENCLOSED IMPELLER



SIZE: 3X4X10B TYPE: 410 IMPELLER: ENCLOSED R.P.M.: 1440

MAX. SPHERES 13 mm
 IMP. PATT. NO. 444A131
 CASE PATT. NO.
 180A027 UPPER (ALL)
 180A028 LOWER (411)
 180A023 LOWER (412 & 413)
 MIN. IMP. DIA. 152 mm

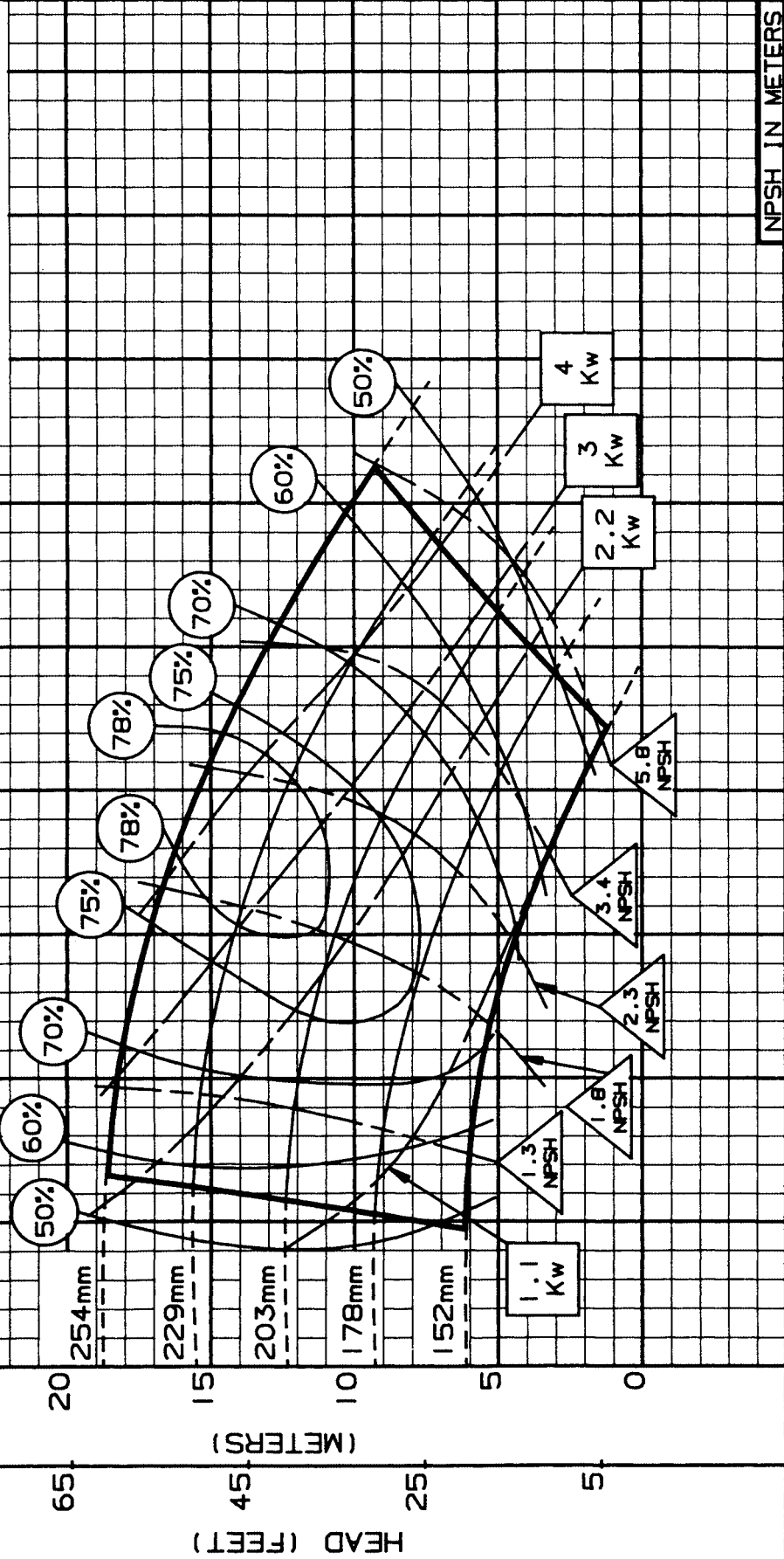

M ³ /HR	0	100	200	300	400	500	600	700	180
L/S	0	10	20	30	40	50	60	70	180
U.S. GPM	0	100	200	300	400	500	600	700	180
DRAWN BY: <i>RAN</i> APPROVED BY: <i>DL</i> DATE: 7-90 PC-124760M									

SIZE: 3X4X10C TYPE: 410 IMPELLER: ENCLOSED R.P.M.: 2950

MAX. SPHERES 16 mm
IMP. PATT. NO. 444A324
CASE PATT. NO.
180A027 UPPER (ALL)
180A028 LOWER (411)
180A023 LOWER (412 & 413)
MIN. IMP. DIA. 178 mm

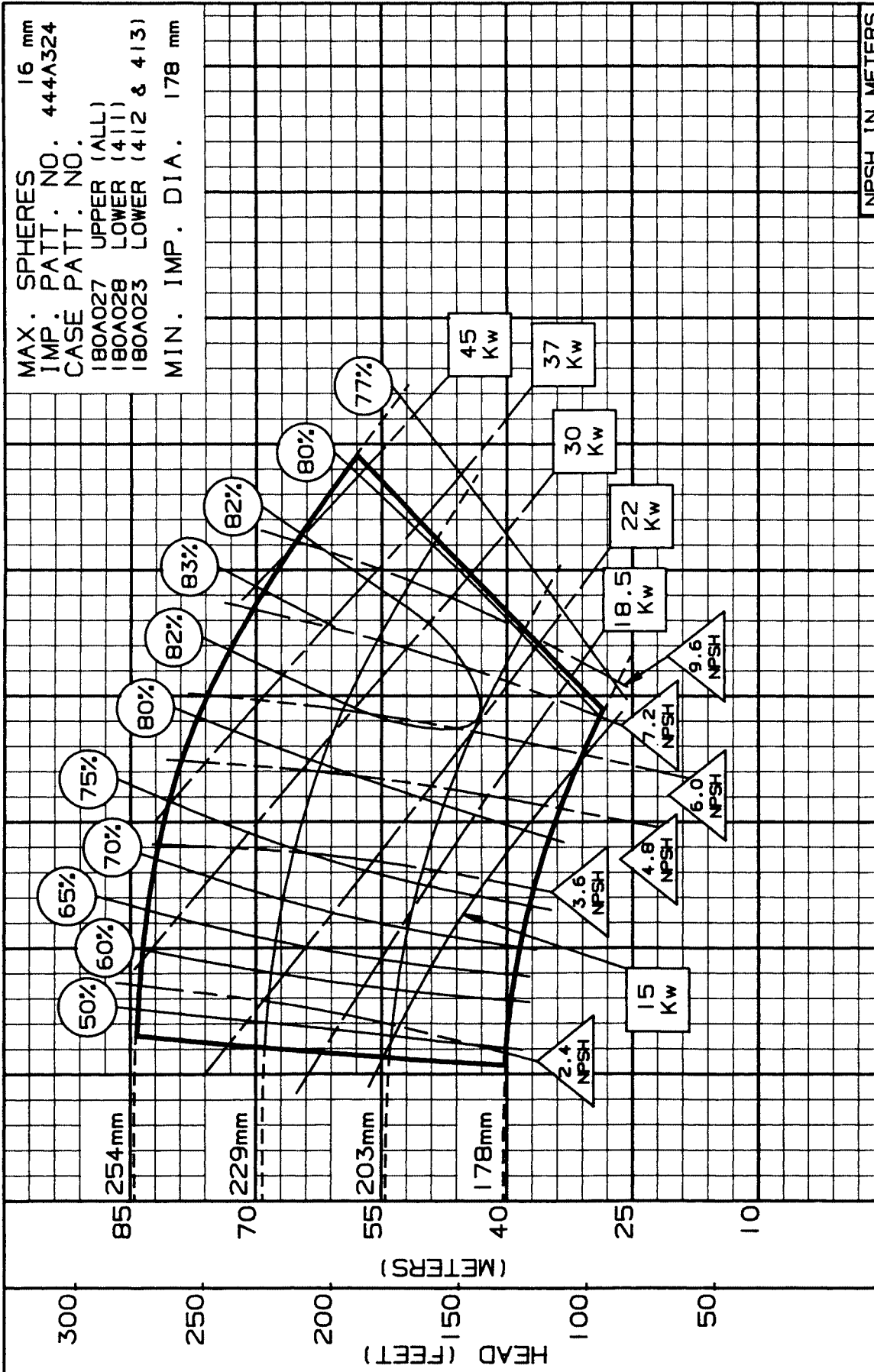

M ³ /HR	0	40	80	120	160	200	240	280	320	360
L/S	15	30	45	60	75	90	100	120	140	150
U.S. GPM	200	400	600	800	1000	1200	1400	1600	1800	2000
DRAWN BY: <i>AK</i> APPROVED BY: DL DATE: 7-90 PC-146727M										

3x4x10C - 1440 RPM
 ENCLOSED IMPELLER

SIZE: 3X4X10C TYPE: 410 IMPELLER: ENCLOSED R.P.M.: 1440

MAX. SPHERES 16 mm
 IMP. PATT. NO. 444A324
 CASE PATT. NO.
 180A027 UPPER (ALL)
 180A028 LOWER (411)
 180A023 LOWER (412 & 413)
 MIN. IMP. DIA. 178 mm

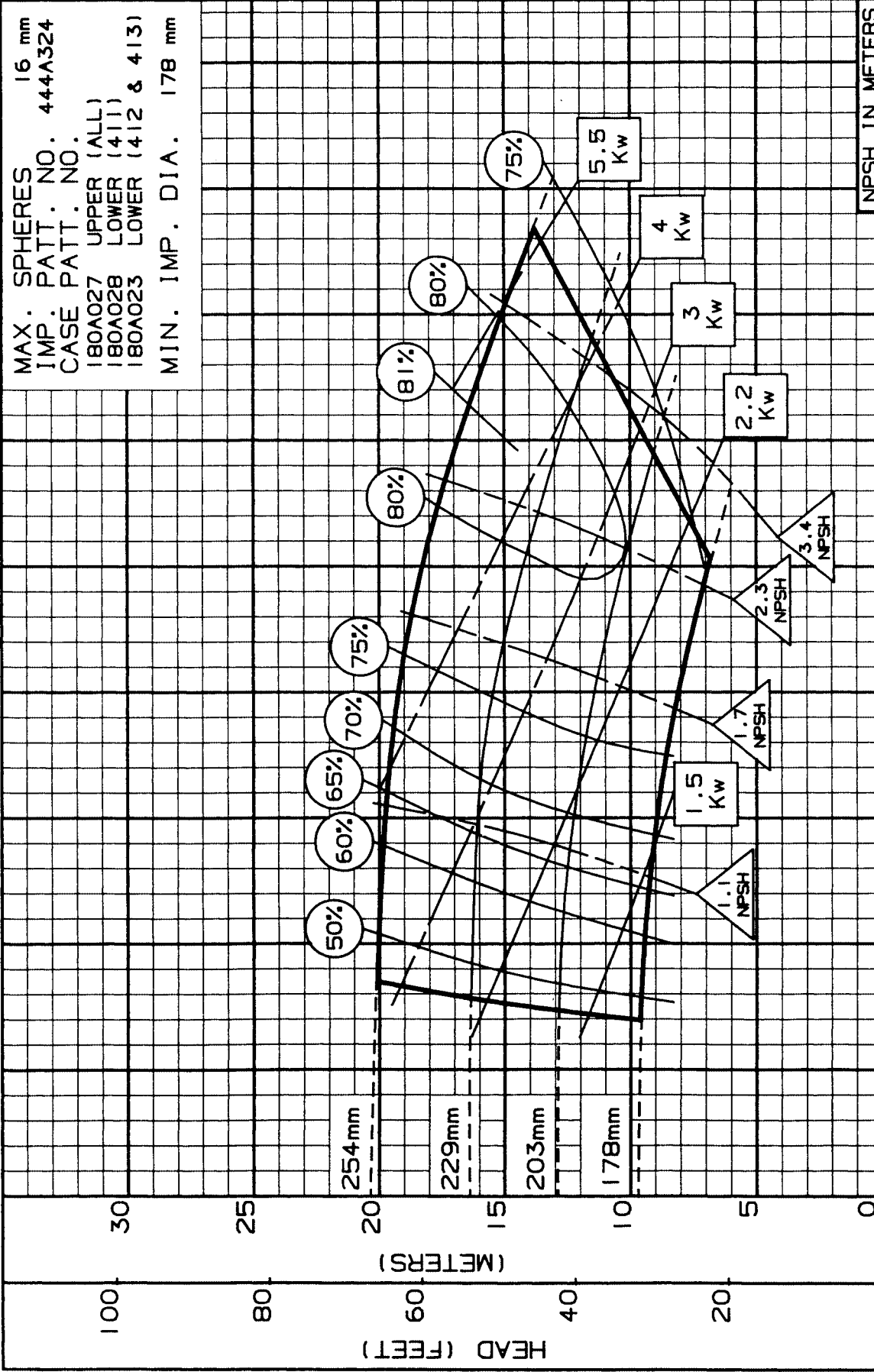

M ³ /HR	0	15	30	45	60	75	90	105	120	135
L/S	0	5	10	15	20	25	30	35	40	45
U.S. GPM	0	75	150	225	300	375	450	525	600	675
DRAWN BY: <i>AMC</i> APPROVED BY: DL DATE: 7-90										
PC-146728M										

SIZE: 3X4X14 TYPE: 410 IMPELLER: ENCLOSED R.P.M.: 1440

MAX. SPHERES 16 mm
IMP. PATT. NO. 444A324
CASE PATT. NO.
180A029 UPPER (ALL)
180A030 LOWER (411)
180A074 LOWER (412 & 413)
MIN. IMP. DIA. 248 mm

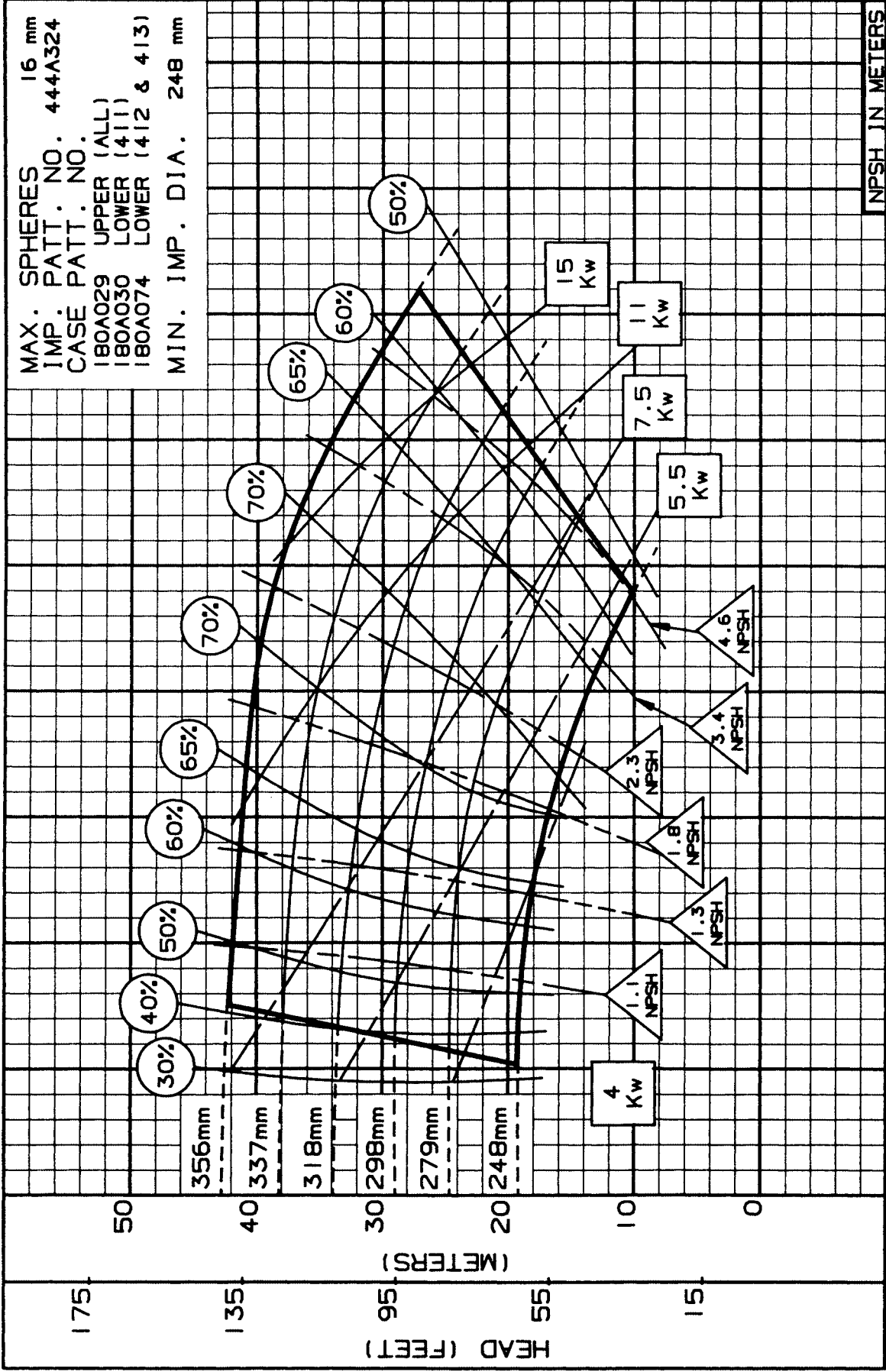

M ³ /HR	0	20	40	60	80	100	120	140	160	180
L/S	0	10	20	30	40	50	60	70	80	90
U.S. GPM	0	100	200	300	400	500	600	700	800	900
NPSH IN METERS										

DRAWN BY: *ATC* APPROVED BY: DL DATE: 7-90 PC-117363M

3x4x14 - 960 RPM
ENCLOSED IMPELLER



SIZE: 3X4X14 TYPE: 410 IMPELLER: ENCLOSED R.P.M.: 960

MAX. SPHERES 16 mm
 IMP. PATT. NO. 444A324
 CASE PATT. NO.
 180A029 UPPER (ALL)
 180A030 LOWER (411)
 180A074 LOWER (412 & 413)
 MIN. IMP. DIA. 248 mm

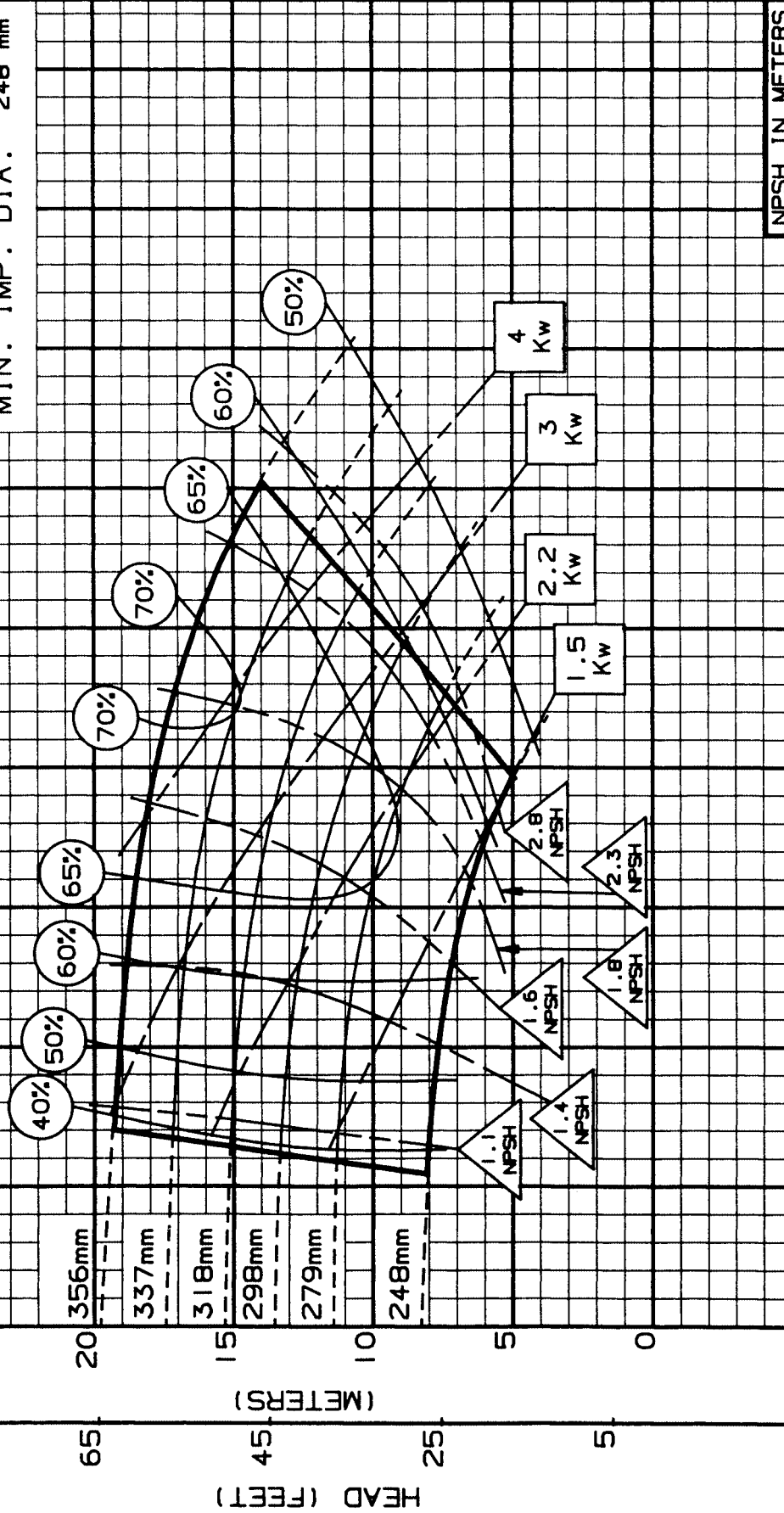

M ³ /HR	0	15	30	45	60	75	90	105	120	135
L/S	5	75	150	225	300	375	450	525	600	675
U.S. GPM	75	150	225	300	375	450	525	600	675	750

DRAWN BY: RAYL APPROVED BY: DL DATE: 7-90 PC-117364M

SIZE: 4X5X10B TYPE: 410 IMPELLER: ENCLOSED R.P.M.: 2880

MAX. SPHERES 16 mm
IMP. PATT. NO. 444A133
CASE PATT. NO.
180A027 UPPER (ALL)
180A032 LOWER (411)
180A075 LOWER (412 & 413)
MIN. IMP. DIA. 146 mm

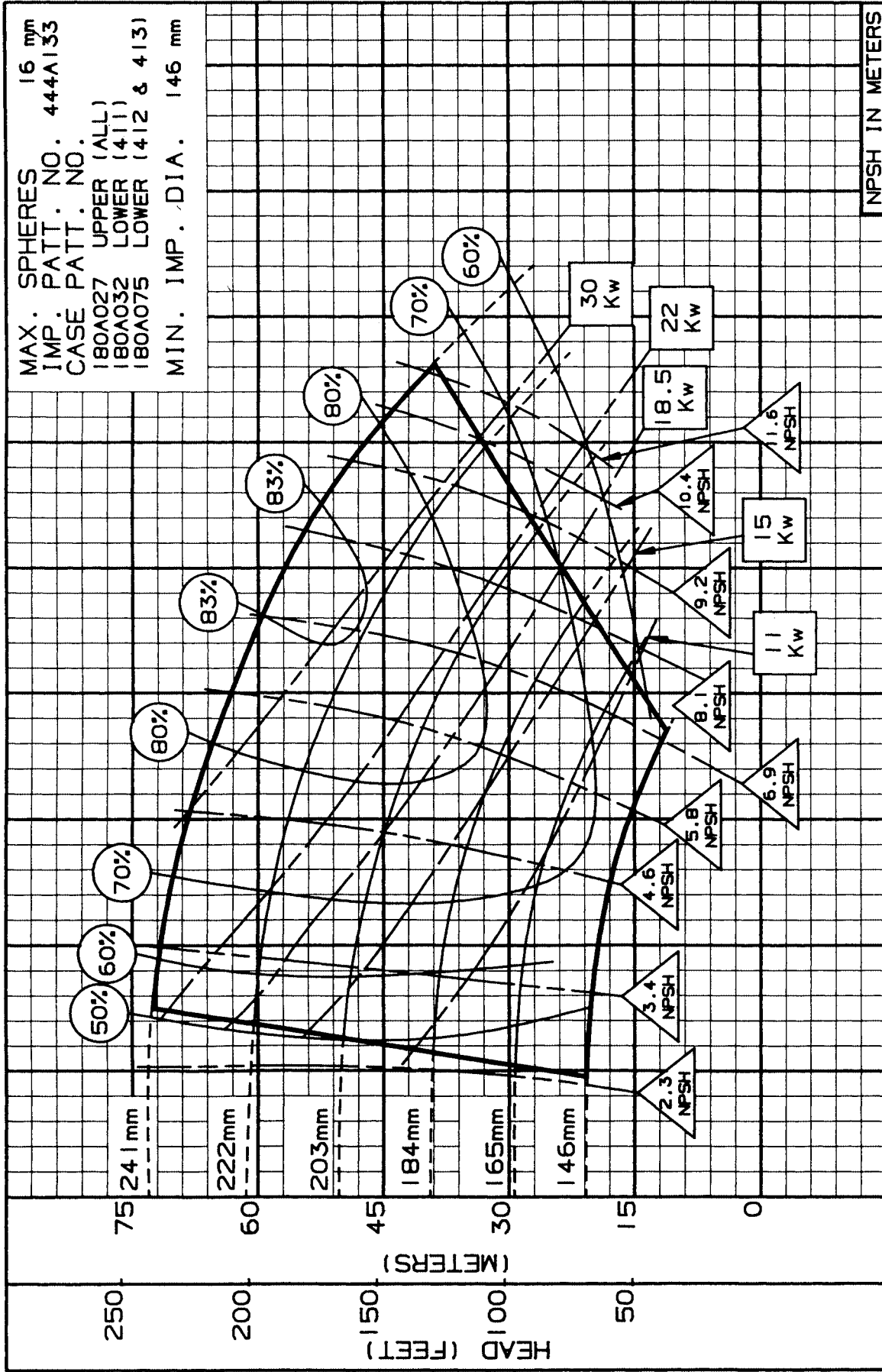

M ³ /HR	0	40	80	120	160	200	240	280	320	360
L/S	0	15	30	45	60	75	90	100	120	140
U.S. GPM	0	200	400	600	800	1000	1200	1400	1600	1800

NPSH IN METERS

DRAWN BY: *AP/L* APPROVED BY: DL DATE: 7-90 PC-117367M

SIZE: 4X5X10B TYPE: 410 IMPELLER: ENCLOSED R.P.M.: 1440

MAX. SPHERES 16 mm
 IMP. PATT. NO. 444A133
 CASE PATT. NO.
 180A027 UPPER (ALL)
 180A032 LOWER (411)
 180A075 LOWER (412 & 413)
 MIN. IMP. DIA. 146 mm

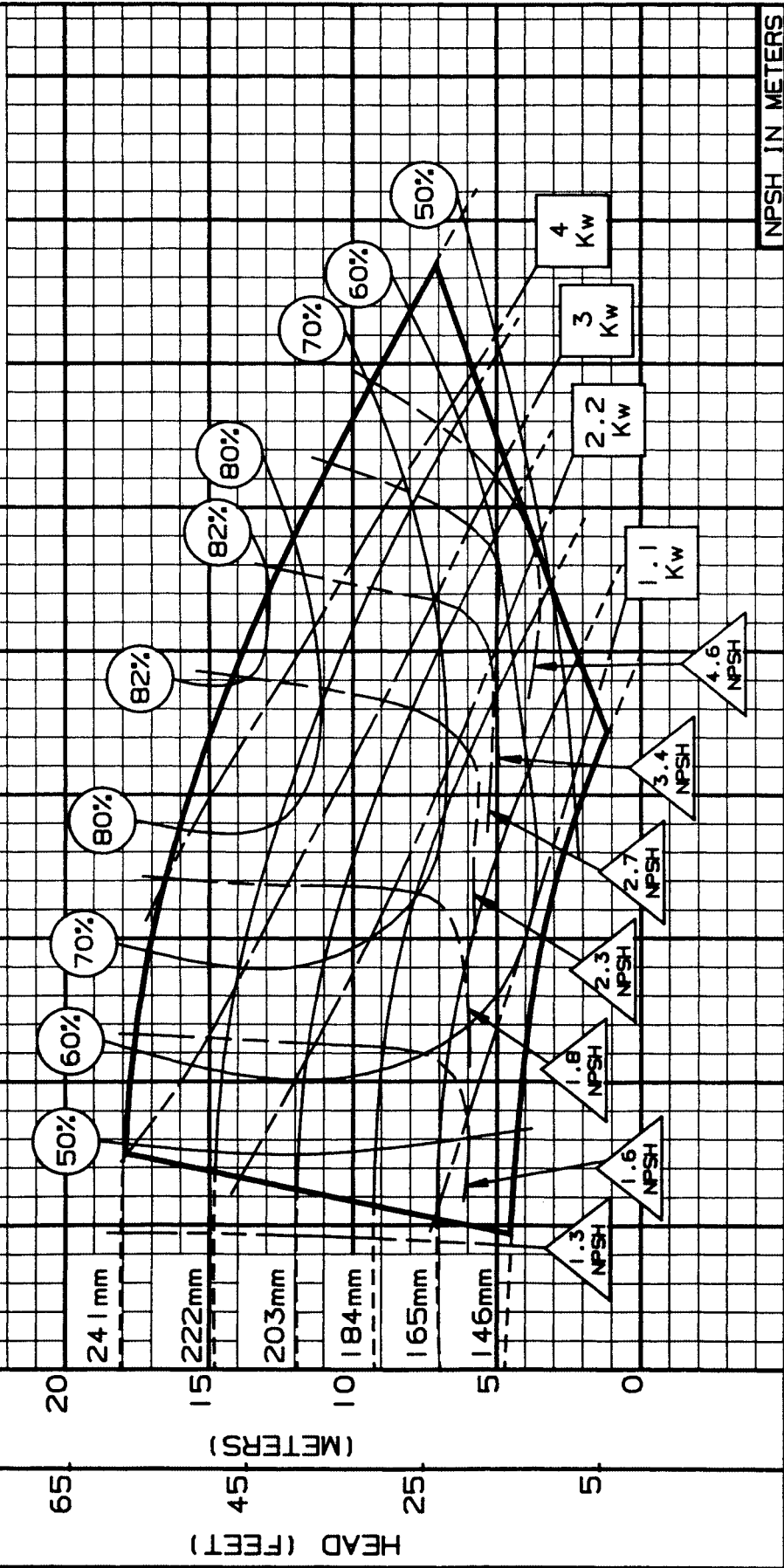

M ³ /HR	0	10	20	30	40	50	60	70	80	90	100	110	120	130	140	150	160	170	180	
L/S																				
U.S. GPM	0	100	200	300	400	500	600	700												
NPSH IN METERS																				

DRAWN BY: *RPN* APPROVED BY: DL DATE: 7-90 PC-117368M

SIZE: 4X5X11A TYPE: 410 IMPELLER: ENCLOSED R.P.M.: 1440

MAX. SPHERES 16 mm
 IMP. PATT: NO. 444A325
 CASE PATT: NO.
 180A035 UPPER (ALL)
 180A036 LOWER (411)
 180A076 LOWER (412 & 413)
 MIN. IMP. DIA. 203 mm

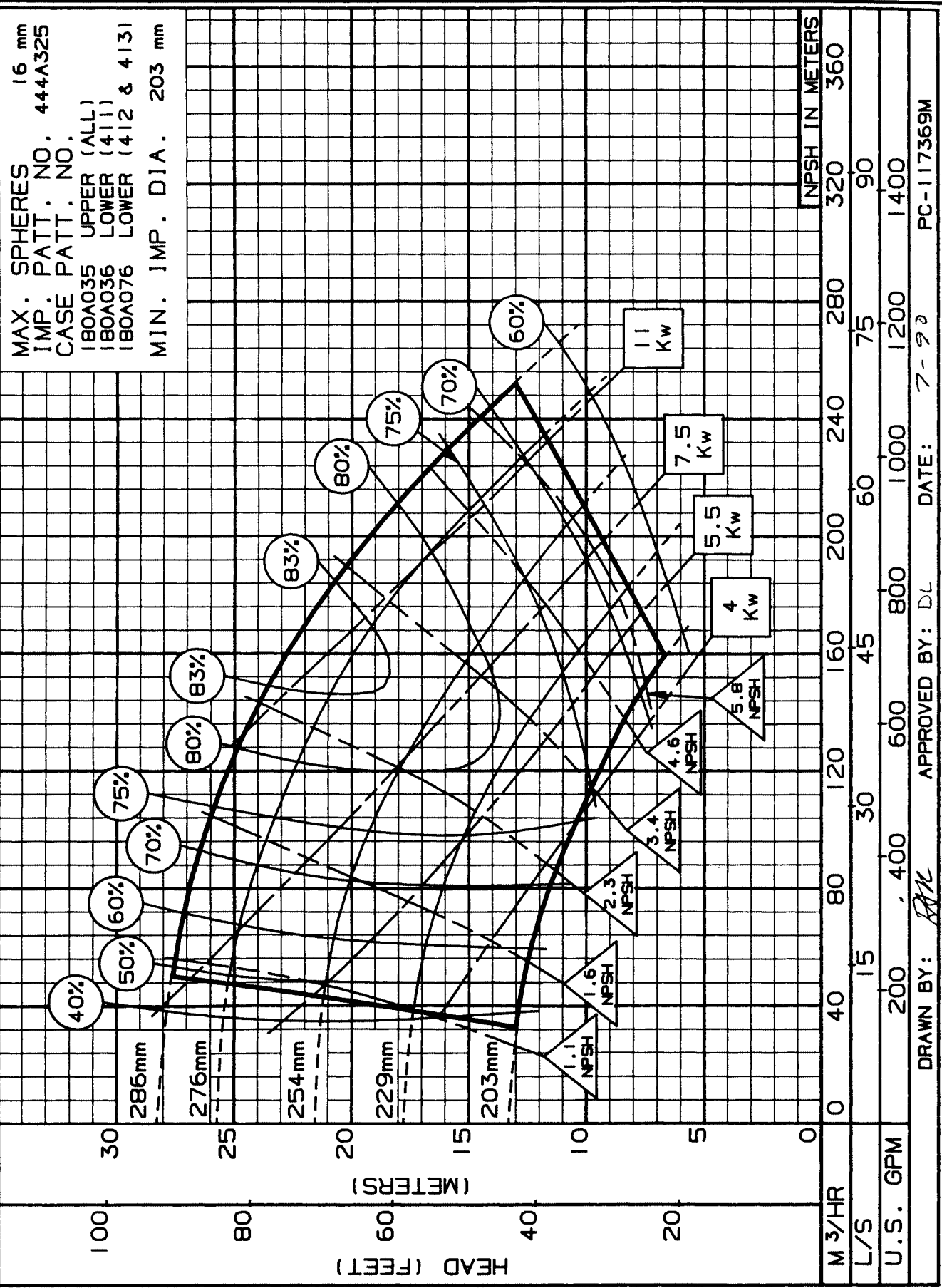

DRAWN BY: *SK* APPROVED BY: DL DATE: 7-90 PC-117369M

4x5x11A - 960 RPM

ENCLOSED IMPELLER



Pentair Pump Group

SIZE: 4X5X11A TYPE: 410 IMPELLER: ENCLOSED R.P.M.: 960

MAX. SPHERES 16 mm
 IMP. PATT. NO. 444A325
 CASE PATT. NO.
 180A035 UPPER (ALL)
 180A036 LOWER (411)
 180A076 LOWER (412 & 413)
 MIN. IMP. DIA. 203 mm

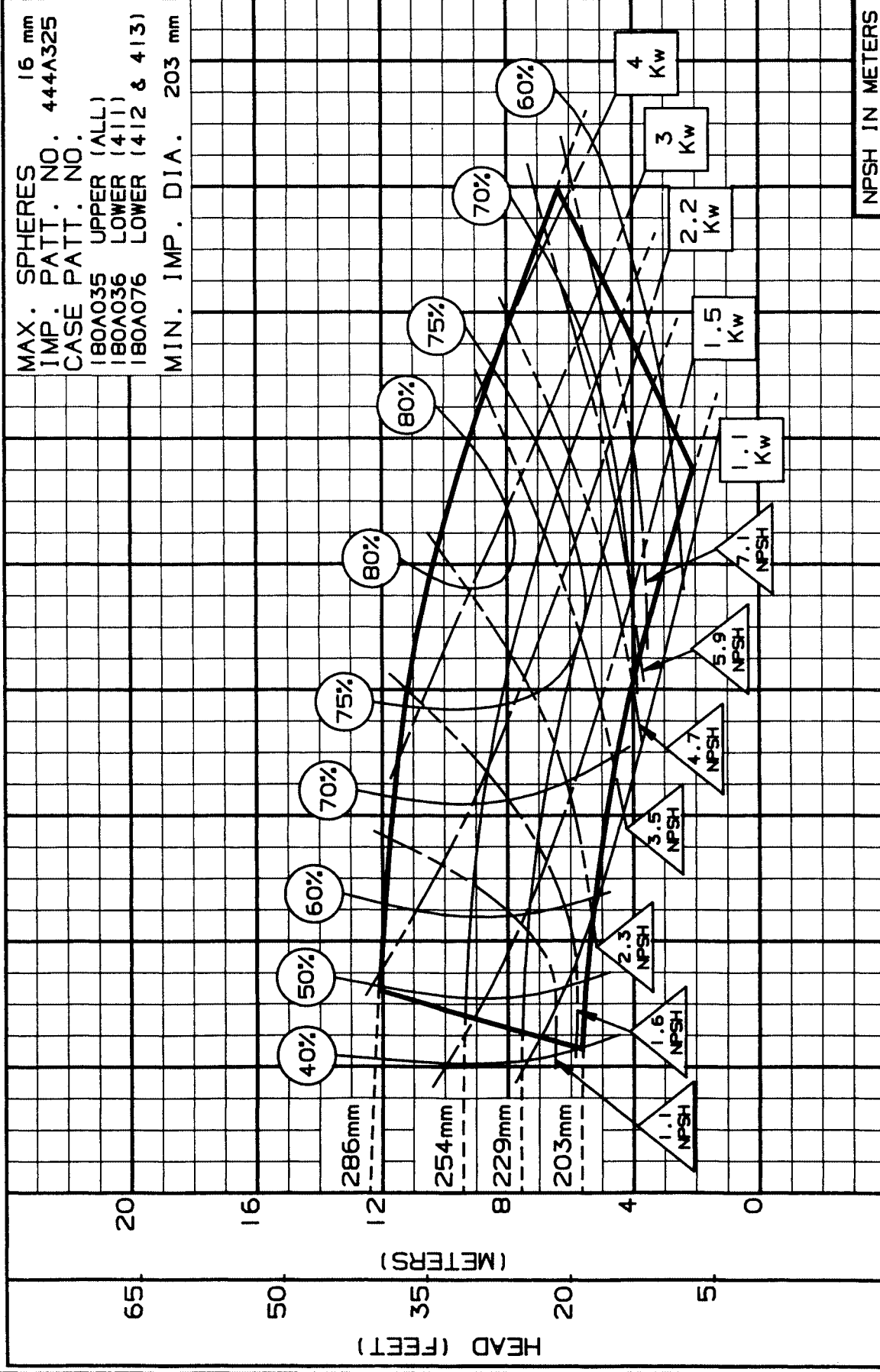

M ³ /HR	0	20	40	60	80	100	120	140	160	180
L/S	0	10	20	30	40	50	60	70	80	90
U.S. GPM	0	100	200	300	400	500	600	700	800	900
DRAWN BY: <i>AKZ</i> APPROVED BY: DL DATE: 7-90 PC-117370M										

SIZE: 4X5X11C TYPE: 410 IMPELLER: ENCLOSED R.P.M.: 2950

MAX. SPHERES 13 mm
IMP. PATT. NO. 444A135
CASE PATT. NO.
180A035 UPPER (ALL)
180A036 LOWER (411)
180A076 LOWER (412 & 413)
MIN. IMP. DIA. 184 mm

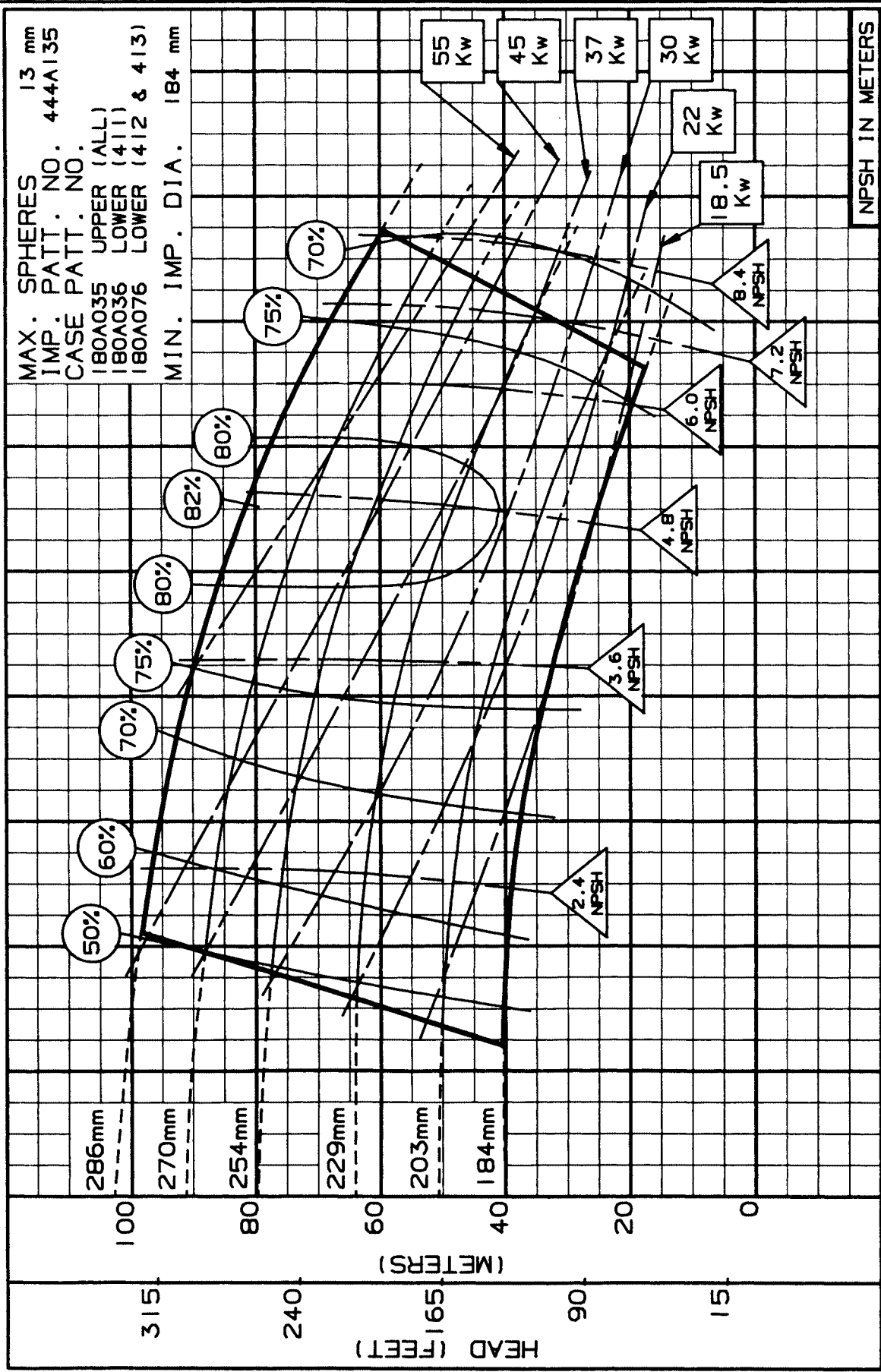

M ³ /HR	0	40	80	120	160	200	240	280	320	360
L/S	15	30	45	60	75	90	100	120	140	180
U.S. GPM	200	400	600	800	1000	1200	1400	1600	1800	2400
NPSH IN METERS										

DRAWN BY: *SAX* APPROVED BY: DL DATE: 7-90 PC-148337M

SECTION 410 (Metric 50Hz)

DATE JULY 1994

SUPERCEDES MARCH 1986

4x5x11C - 1440 RPM

ENCLOSED IMPELLER

ap AURORA®

Pentair Pump Group

SIZE: 4X5X11C TYPE: 410 IMPELLER: ENCLOSED R.P.M.: 1440

MAX. SPHERES 13 mm
IMP. PATT. NO. 444A135
CASE PATT. NO.
180A035 UPPER (ALL)
180A036 LOWER (411)
180A076 LOWER (412 & 413)
MIN. IMP. DIA. 184 mm

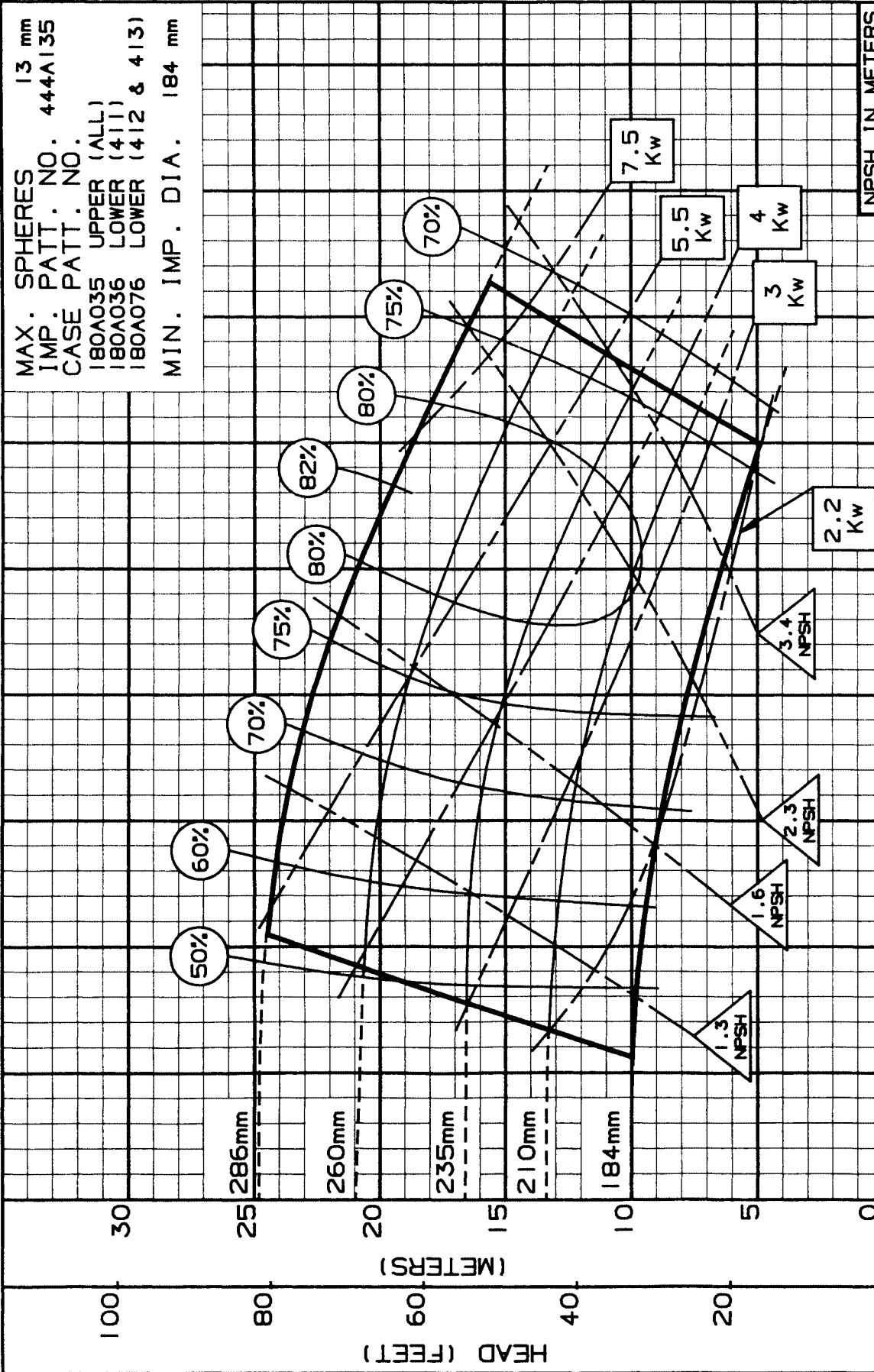

M ³ /HR	0	20	40	60	80	100	120	140	160	180
L/S	0	10	20	30	40	50	60	70	80	90
U.S. GPM	0	100	200	300	400	500	600	700	800	900
NPSH IN METERS										
DRAWN BY: <i>RAL</i> APPROVED BY: DL DATE: 7-90 PC-117372M										

SIZE: 4X5X15 TYPE: 410 IMPELLER: ENCLOSED R.P.M.: 1440

MAX. SPHERES 16 mm
IMP. PATT. NO. 444A327
CASE PATT. NO.
180A041 UPPER (ALL)
180A044 LOWER (411)
180A081 LOWER (412 & 413)
MIN. IMP. DIA. 279 mm

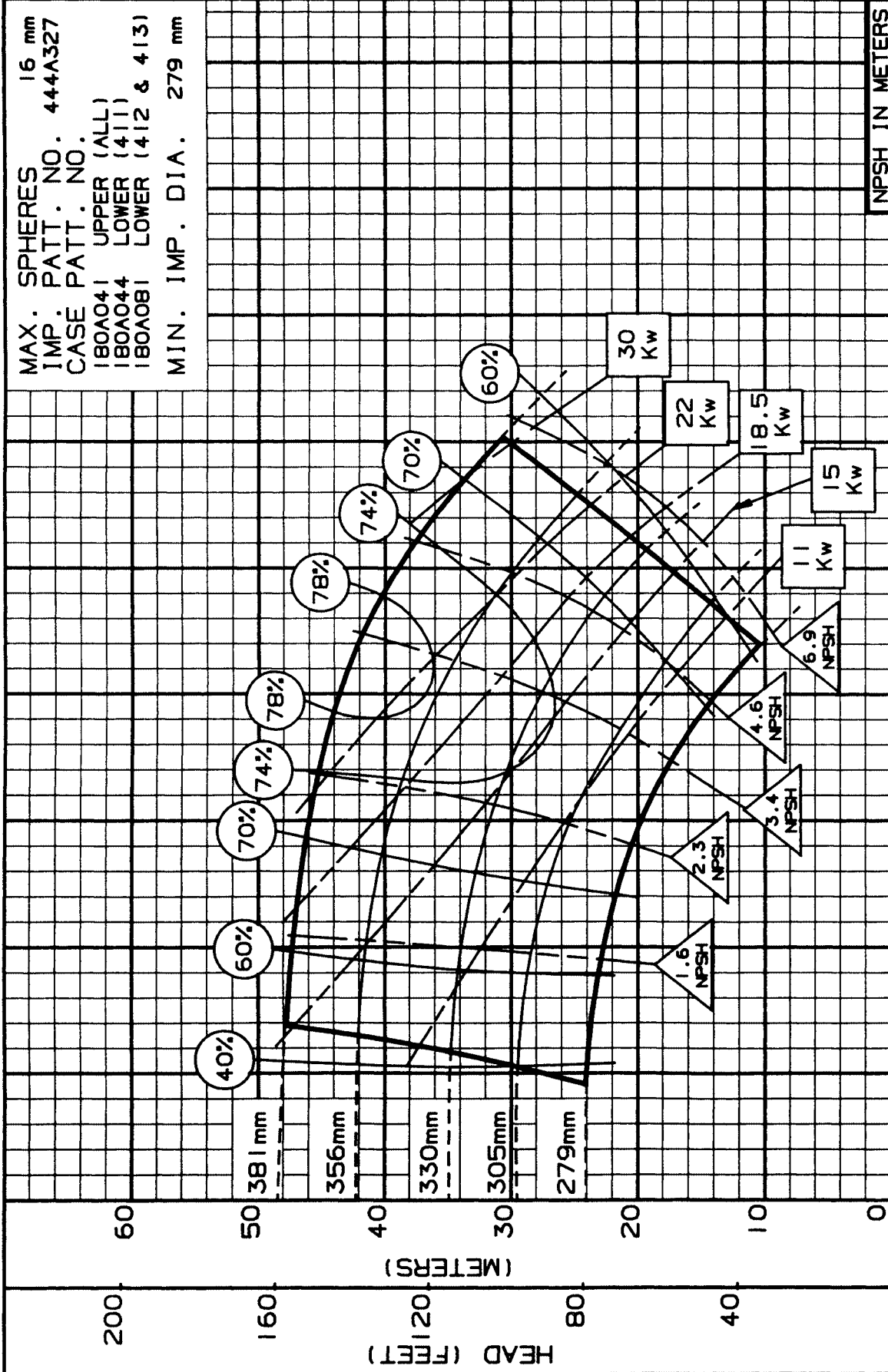

M ³ /HR	0	40	80	120	160	200	240	280	320	360
L/S	15	30	45	60	75	90	100	120	140	140
U.S. GPM	200	400	600	800	1000	1200	1400	1400	1400	1400
NPSH IN METERS										

DRAWN BY: *ABC* APPROVED BY: DL DATE: 7-90 PC-117373M

SECTION 410 (Metric 50Hz)
 DATE JULY 1994
 SUPERCEDES MARCH 1986

4x5x15 - 960 RPM
 ENCLOSED IMPELLER



SIZE: 4X5X15 TYPE: 410 IMPELLER: ENCLOSED R.P.M.: 960

MAX. SPHERES 16 mm
 IMP. PATT. NO. 444A327
 CASE PATT. NO.
 180A041 UPPER (ALL)
 180A044 LOWER (411)
 180A081 LOWER (412 & 413)
 MIN. IMP. DIA. 279 mm

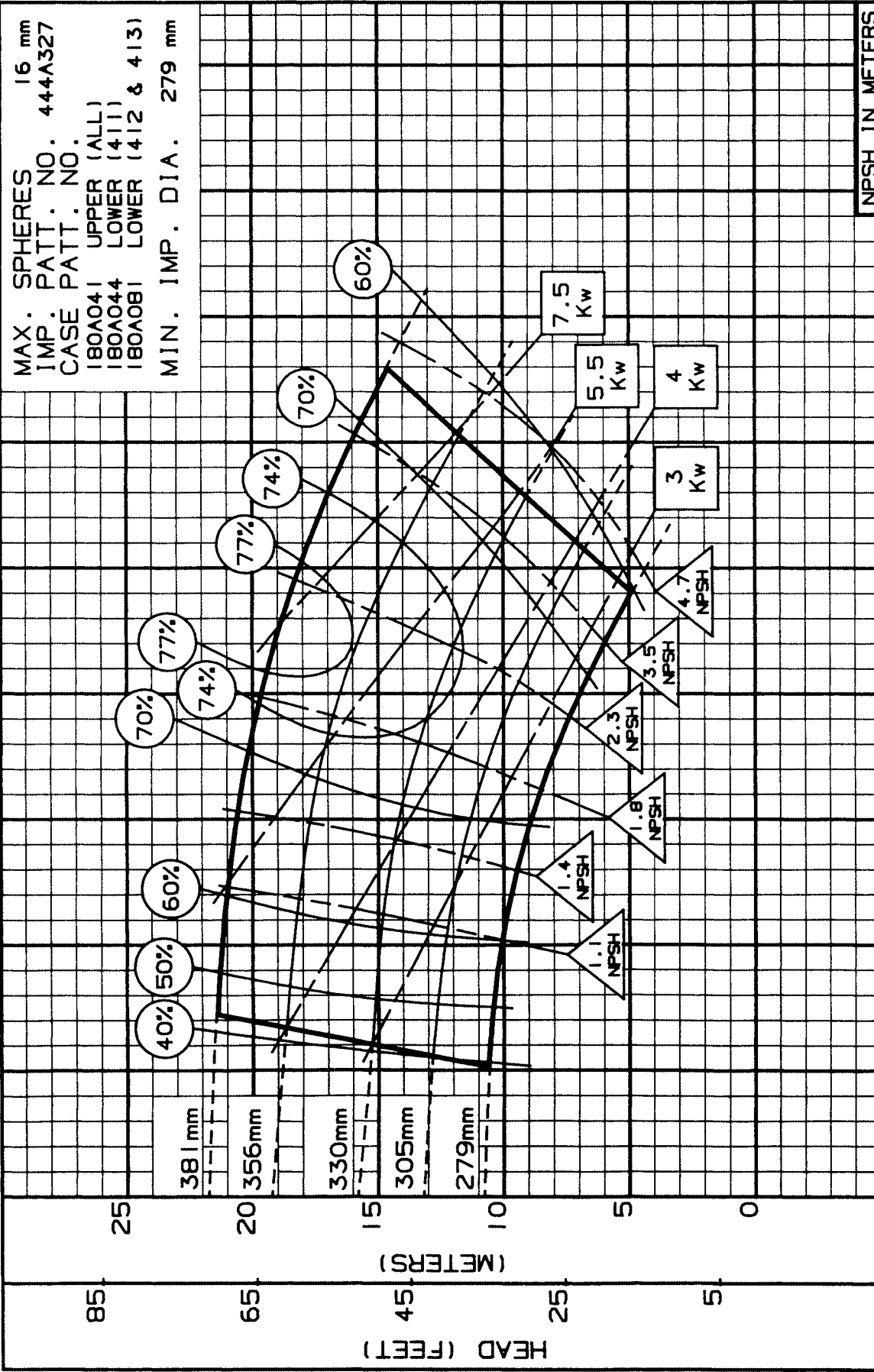

M ³ /HR	0	25	50	75	100	125	150	175	200	225
L/S	0	10	20	30	40	50	60	70	80	90
U.S. GPM	0	150	300	450	600	750	900	1050	1200	1350
NPSH IN METERS	0	0.3	0.4	0.5	0.6	0.7	0.8	0.9	1.0	1.1

DRAWN BY: *AKK* APPROVED BY: DL DATE: 7-90 PC-117374M

SIZE: 4X6X18B TYPE: 410 IMPELLER: ENCLOSED R.P.M.: 1475

MAX. SPHERES 14 mm
IMP. PATT. NO. 444A142
CASE PATT. NO.
180A215 UPPER (ALL)
180A216 LOWER (411)
180A259 LOWER (412 & 413)
MIN. IMP. DIA. 394 mm

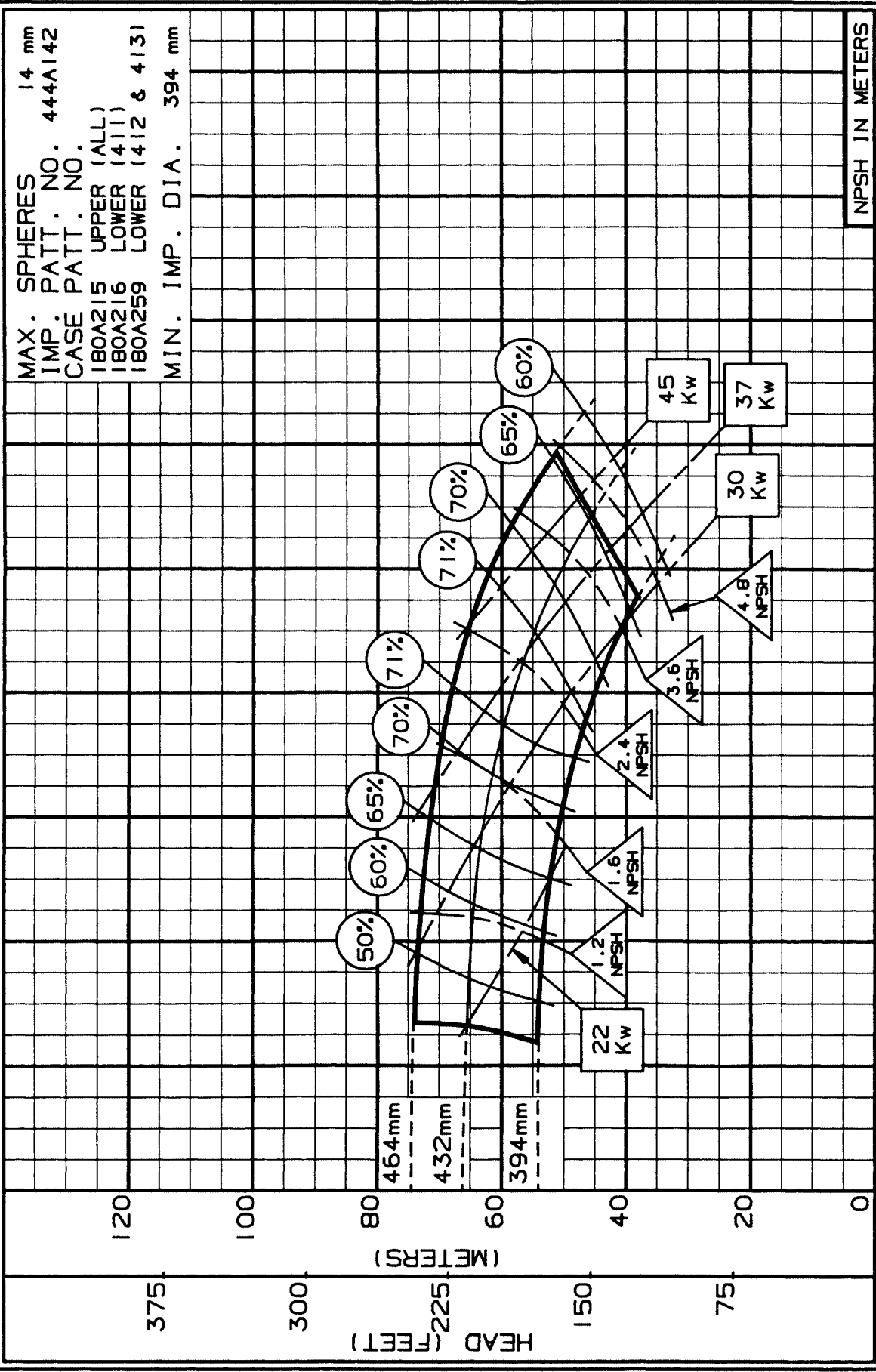

M³/HR 0 40 80 120 160 200 240 280 320 360
L/S 15 30 45 60 75 90
U.S. GPM 200 400 600 800 1000 1200 1400
DRAWN BY: *AKC* APPROVED BY: DL DATE: 7-90 PC-117375M

4x6x18B - 960 RPM

ENCLOSED IMPELLER



Pentair Pump Group

SIZE: 4X6X18B TYPE: 410 IMPELLER: ENCLOSED R.P.M.: 960

MAX. SPHERES 14 mm
 IMP. PATT. NO. 444A142
 CASE PATT. NO.
 180A215 UPPER (ALL)
 180A216 LOWER (411)
 180A259 LOWER (412 & 413)
 MIN. IMP. DIA. 394 mm

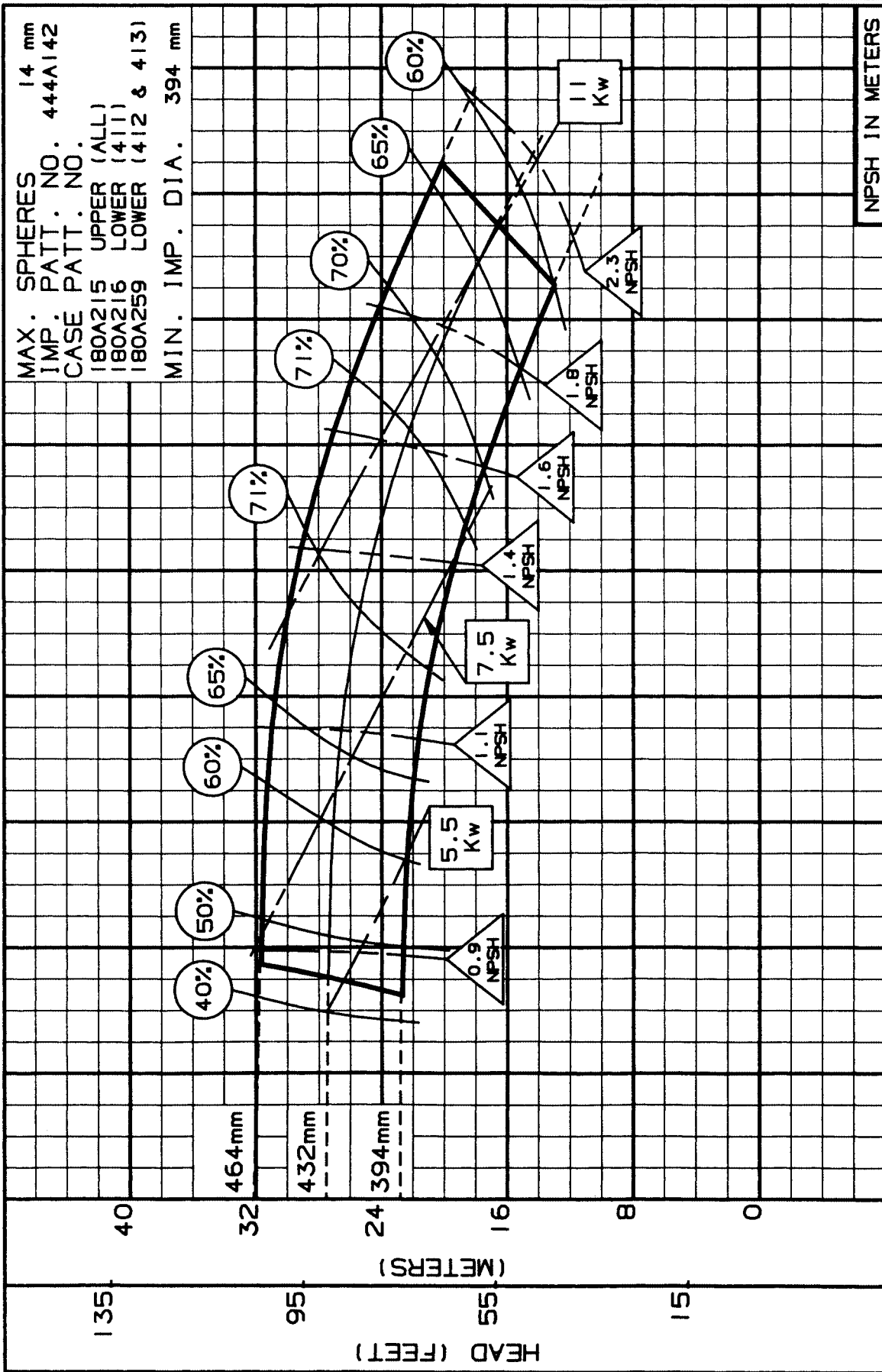

M ³ /HR	0	20	40	60	80	100	120	140	160	180
L/S	0	10	20	30	40	50	60	70	80	90
U.S. GPM	0	100	200	300	400	500	600	700	800	900

DRAWN BY: *AK* APPROVED BY: DL DATE: 7-90 PC-117376M

SIZE: 5X6X11A TYPE: 410 IMPELLER: ENCLOSED R.P.M.: 1440

MAX. SPHERES 25 mm
IMP. PATT. NO. 444A325
CASE PATT. NO.
180A039 UPPER (ALL)
180A040 LOWER (411)
180A079 LOWER (412 & 413)
MIN. IMP. DIA. 184 mm

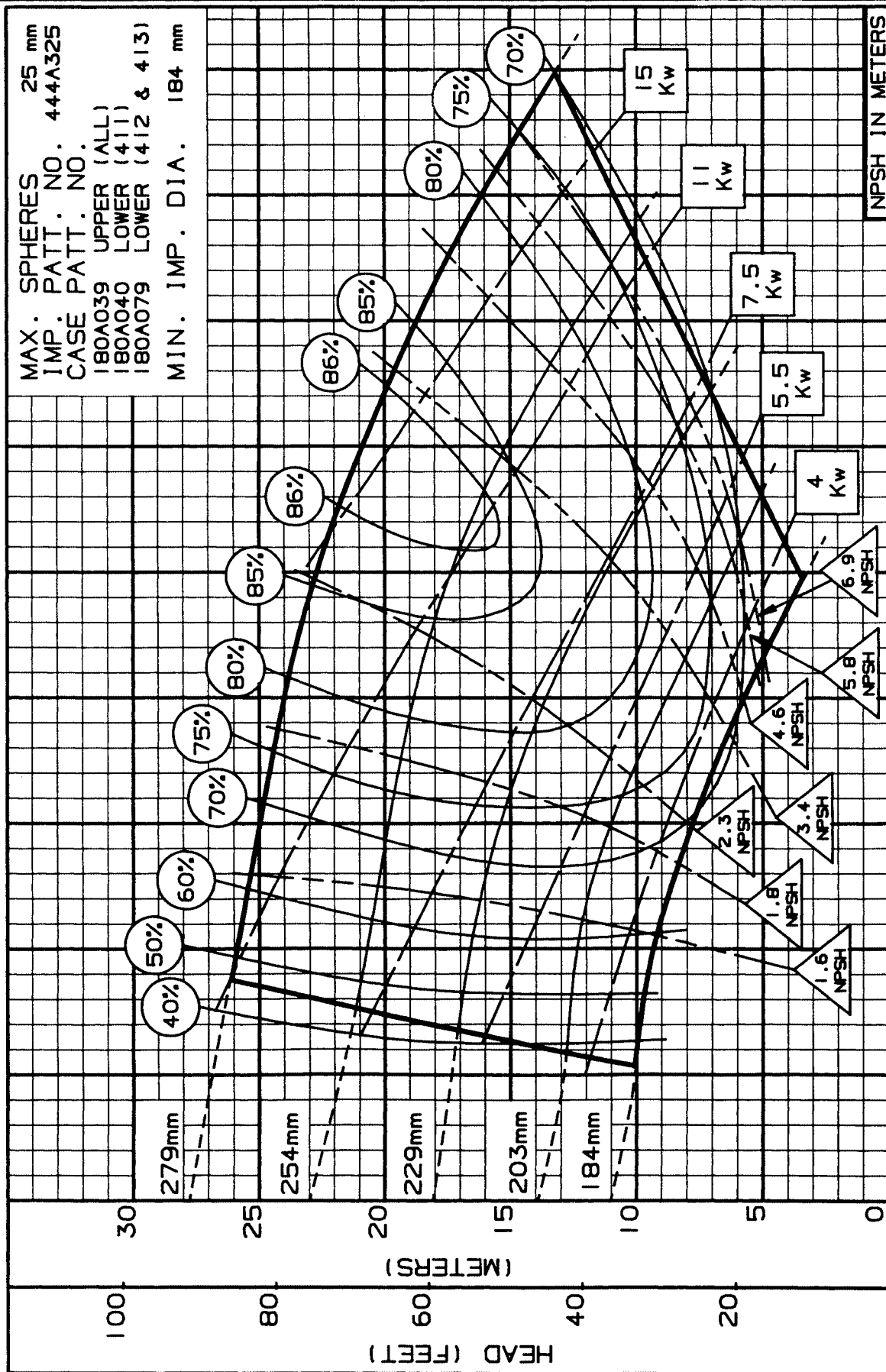

M ³ /HR	0	40	80	120	160	200	240	280	320	360
L/S	0	15	30	45	60	75	90	100	1200	1400
U.S. GPM	0	200	400	600	800	1000	1200	1400	1400	1400
DRAWN BY: <i>ATL</i> APPROVED BY: DL DATE: 7-90 PC-117377M										

5x6x11A - 960 RPM

ENCLOSED IMPELLER



SIZE: 5X6X11A TYPE: 410 IMPELLER: ENCLOSED R.P.M.: 960

MAX. SPHERES 25 mm
 IMP. PATT. NO. 444A325
 CASE PATT. NO.
 180A039 UPPER (ALL)
 180A040 LOWER (411)
 180A079 LOWER (412 & 413)
 MIN. IMP. DIA. 184 mm

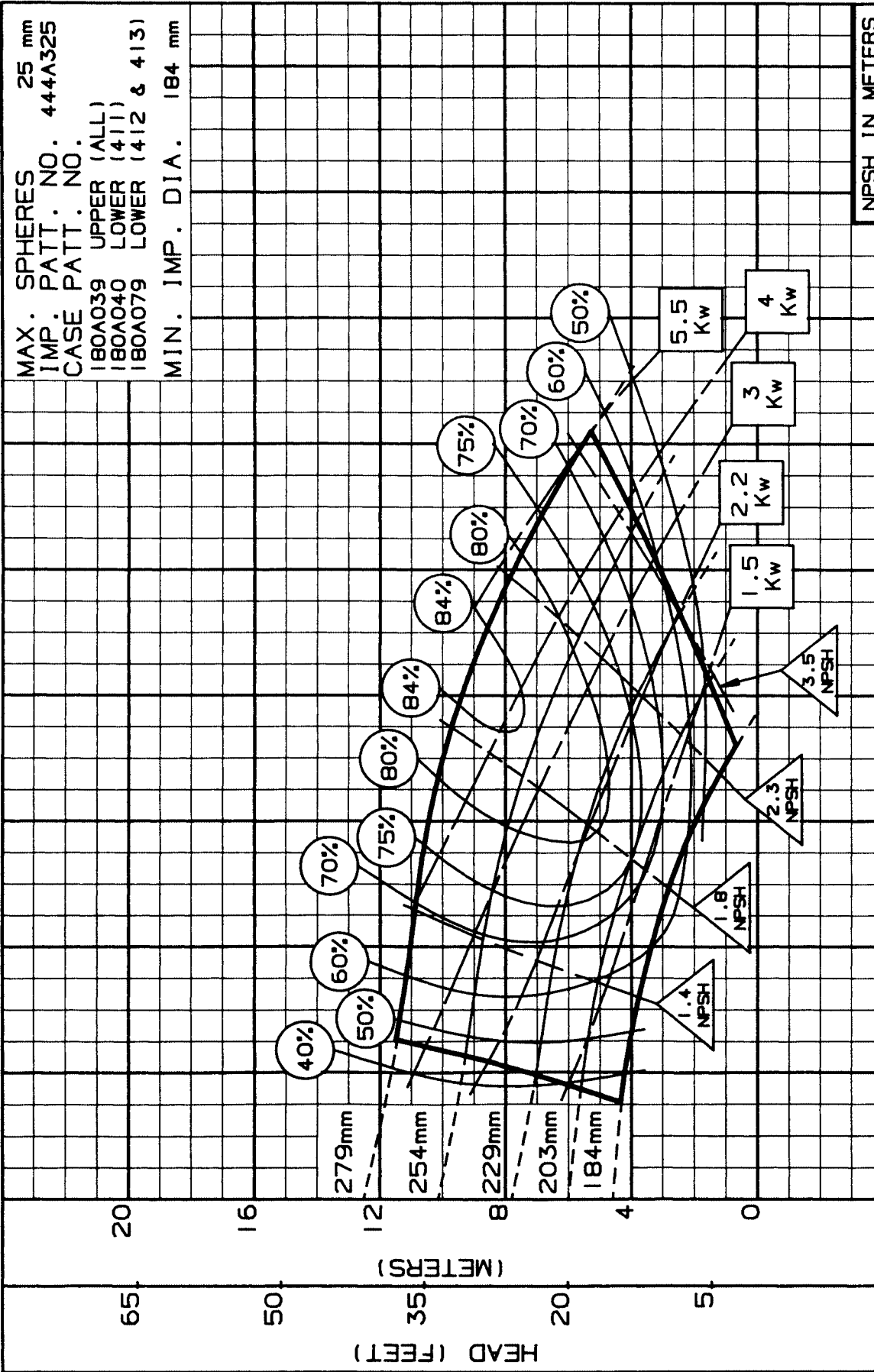

M ³ /HR	0	40	80	120	160	200	240	280	320	360
L/S	0	15	30	45	60	75	90	105	120	140
U.S. GPM	0	200	400	600	800	1000	1200	1400	1600	1800
NPSH IN METERS										

DRAWN BY: *[Signature]* APPROVED BY: DC DATE: 7-90 PC-11737BM

SIZE: 5X6X11C TYPE: 410 IMPELLER: ENCLOSED R.P.M.: 2950

MAX. SPHERES 16 mm
IMP. PATT. NO. 444A184
CASE PATT. NO.
180A263 UPPER (ALL)
180A262 LOWER (411)
180A264 LOWER (412 & 413)
MIN. IMP. DIA. 191 mm

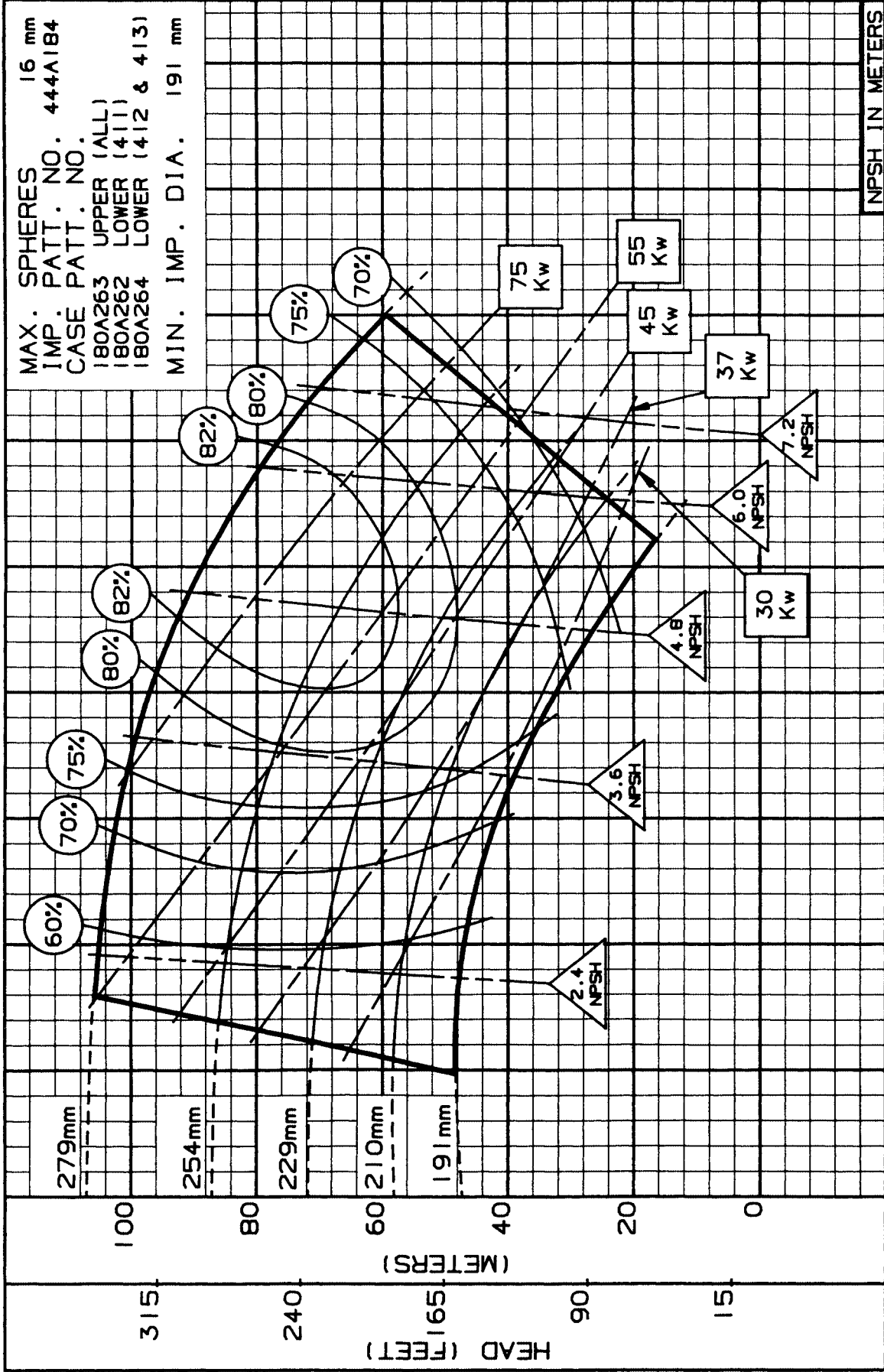

M ³ /HR	0	60	120	180	240	300	360	420	480	540
L/S	0	20	40	60	80	100	120	140	160	180
U.S. GPM	0	400	800	1200	1600	2000	2400	2800	3200	3600
NPSH IN METERS										

DRAWN BY: *AKC* APPROVED BY: DL DATE: 7-90 PC-125241M

5x6x11C - 1440 RPM

ENCLOSED IMPELLER



Pentair Pump Group

SIZE: 5X6X11C TYPE: 410 IMPELLER: ENCLOSED R.P.M.: 1440

MAX. SPHERES 16 mm
 IMP. PATT. NO. 444A184
 CASE PATT. NO.
 180A263 UPPER (ALL)
 180A262 LOWER (411)
 180A264 LOWER (412 & 413)
 MIN. IMP. DIA. 191 mm

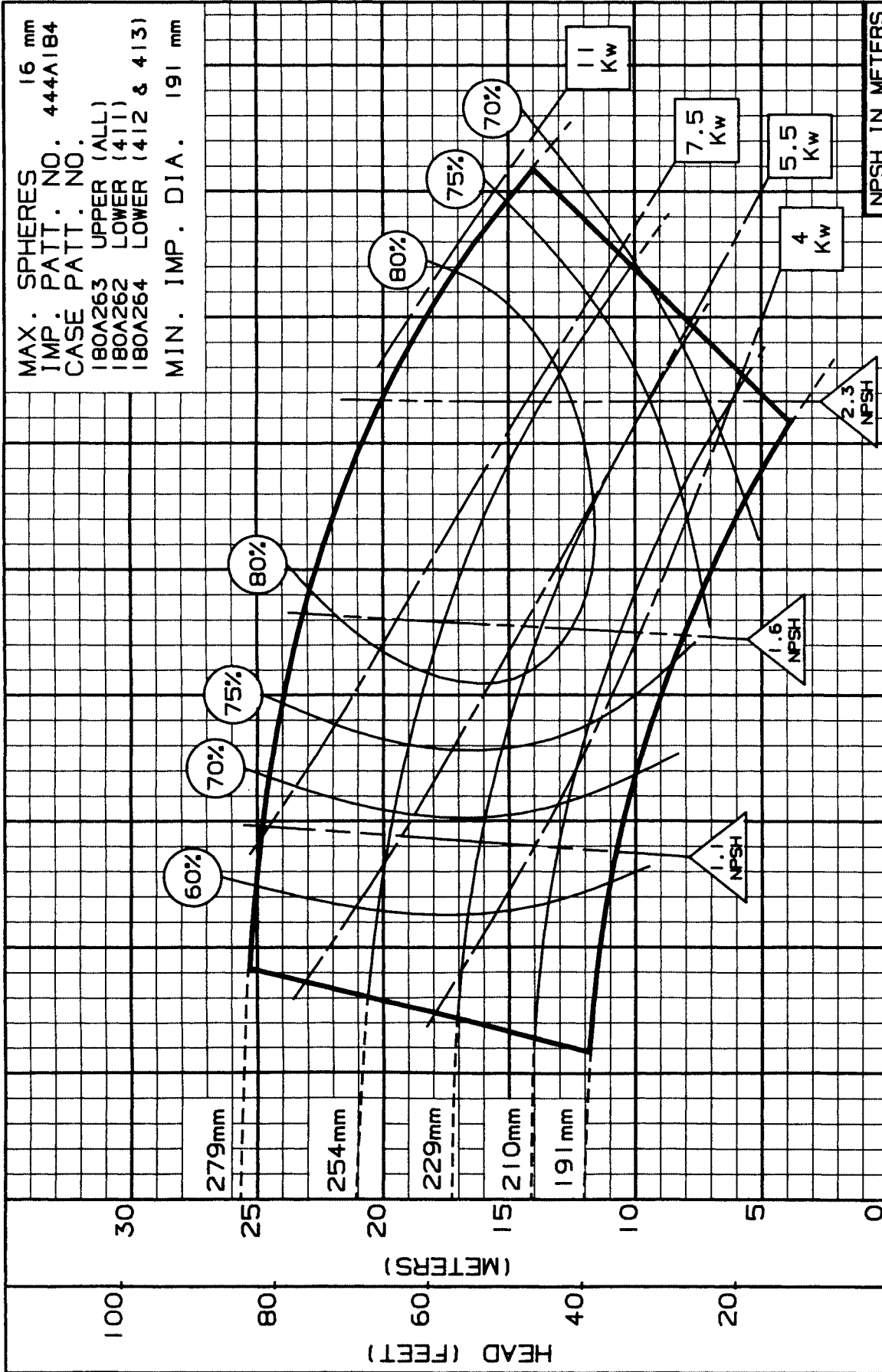

M ³ /HR	0	25	50	75	100	125	150	175	200	225
L/S	0	10	20	30	40	50	60	70	80	90
U.S. GPM	0	150	300	450	600	750	900	1050	1200	1350
NPSH IN METERS										

DRAWN BY: *RAC* APPROVED BY: DL DATE: 7-90 PC-125240M

SIZE: 5X6X15 TYPE: 410 IMPELLER: ENCLOSED R.P.M.: 1440

MAX. SPHERES 21 mm
IMP. PATT. NO. 444A328
CASE PATT. NO.
180A041 UPPER (ALL)
180A042 LOWER (411)
180A080 LOWER (412 & 413)
MIN. IMP. DIA. 254 mm

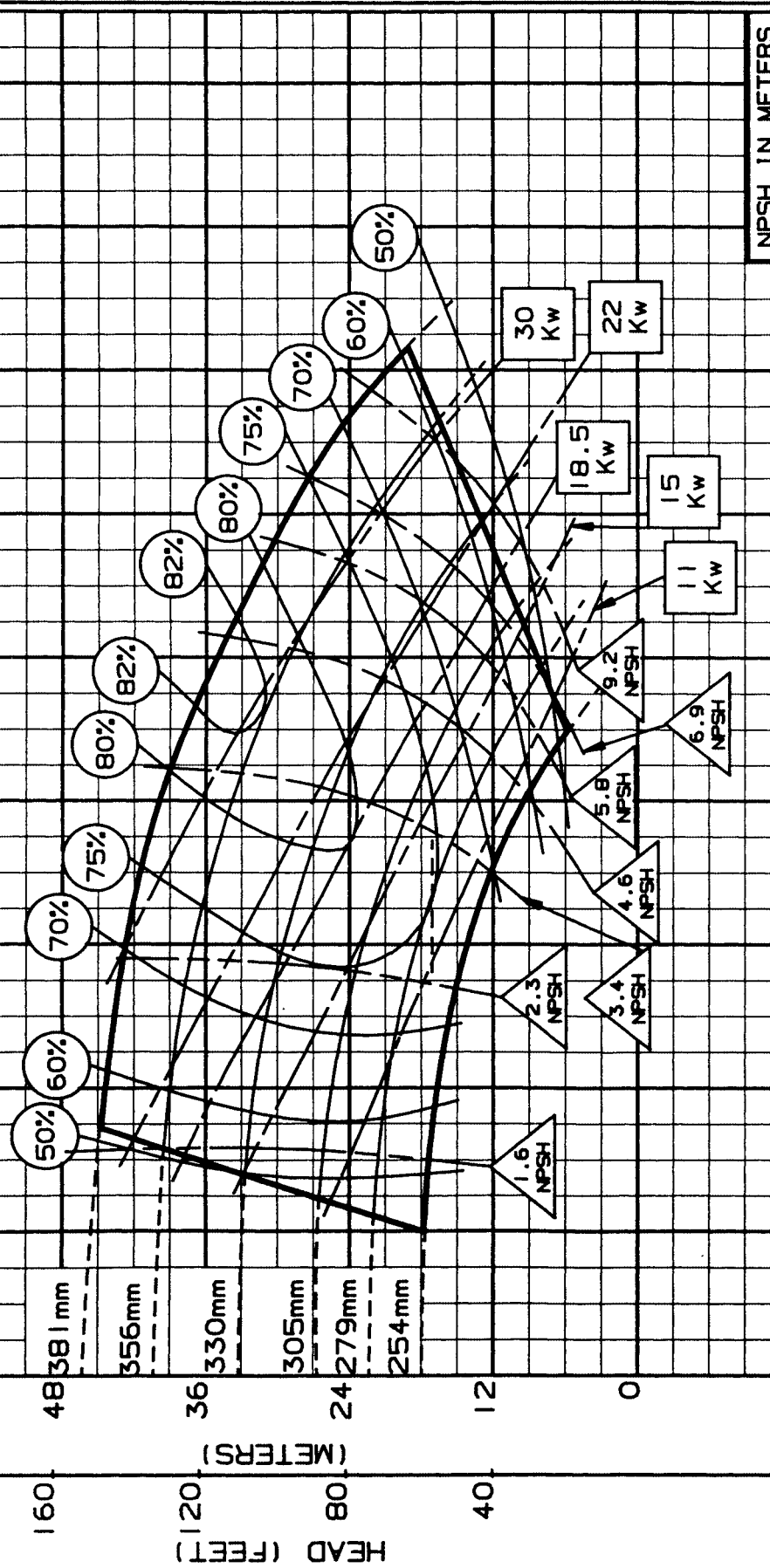

M ³ /HR	0	60	120	180	240	300	360	420	480	540
L/S	0	20	40	60	80	100	120	140	160	180
U.S. GPM	0	400	800	1200	1600	2000	2400	2800	3200	3600
NPSH IN METERS										

DRAWN BY: *RAC* APPROVED BY: DL DATE: 7-90 PC-117379M

5x6x15 - 960 RPM
ENCLOSED IMPELLER



TYPE: 410 IMPELLER: ENCLOSED R.P.M.: 960

SIZE: 5X6X15

MAX. SPHERES 21 mm
 IMP. PATT. NO. 444A328
 CASE PATT. NO.
 180A041 UPPER (ALL)
 180A042 LOWER (411)
 180A080 LOWER (412 & 413)
 MIN. IMP. DIA. 254 mm

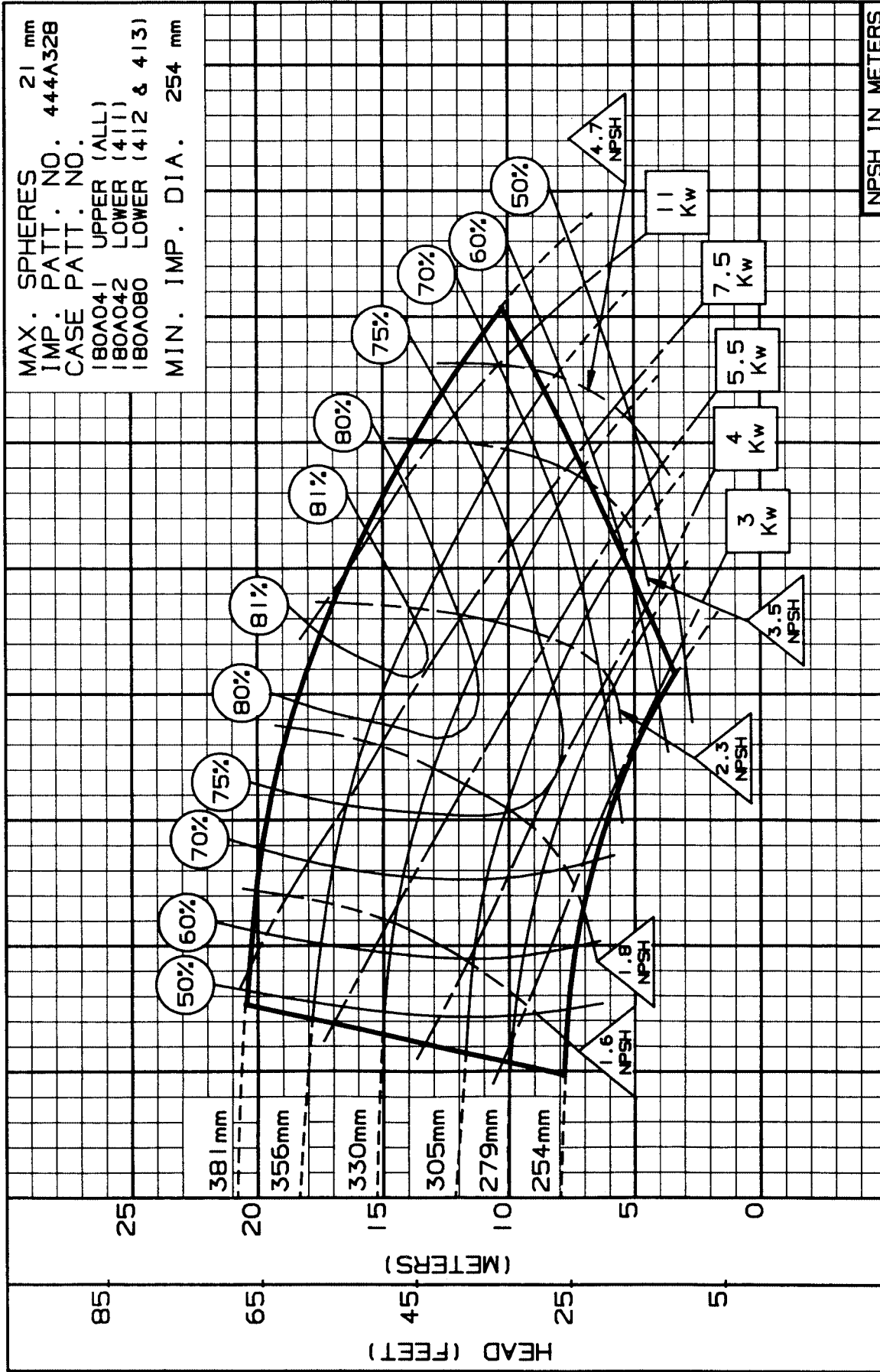

M ³ /HR	0	40	80	120	160	200	240	280	320	360
L/S	15	30	45	60	75	90	100	120	140	
U.S. GPM	200	400	600	800	1000	1200	1400			
NPSH IN METERS										

DRAWN BY: *ATZ* APPROVED BY: DL DATE: 7-90 PC-117380M

SIZE: 5X6X17 TYPE: 410 IMPELLER: ENCLOSED R.P.M.: 1475

MAX. SPHERES 17 mm
IMP. PATT. NO. 444A329
CASE PATT. NO.
180A041 UPPER (ALL)
180A044 LOWER (411)
180A081 LOWER (412 & 413)
MIN. IMP. DIA. 330 mm

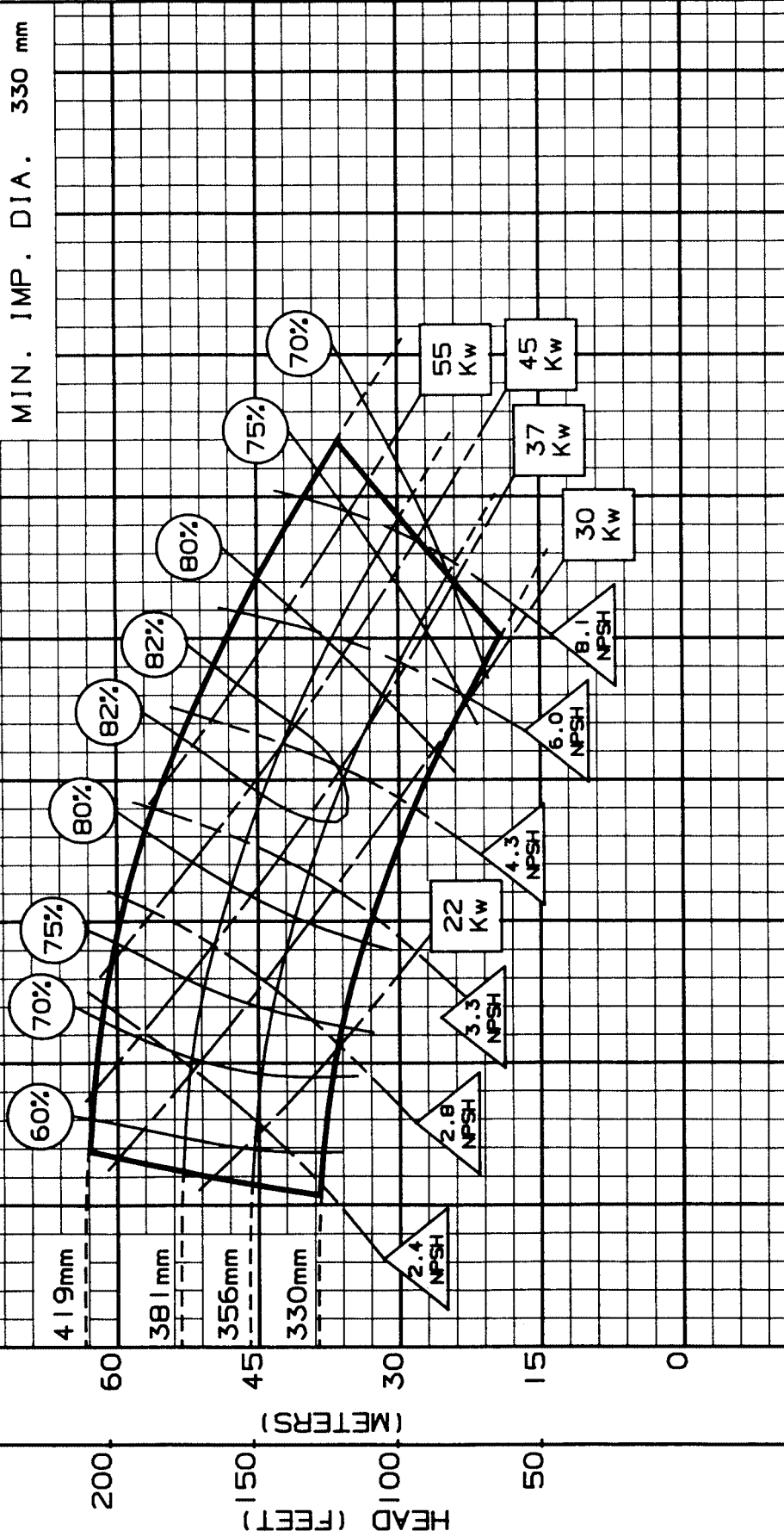

M 3/HR	0	75	150	225	300	375	450	525	600	675
L/S	0	25	50	75	100	125	150	175	200	225
U.S. GPM	0	400	800	1200	1600	2000	2400	2800	3200	3600
NPSH IN METERS										
DRAWN BY: <i>ATL</i> APPROVED BY: <i>DL</i> DATE: 7-90 PC-14478BM										

5X6X17 - 960 RPM

ENCLOSED IMPELLER



Pentair Pump Group

SIZE: 5X6X17 TYPE: 410 IMPELLER: ENCLOSED R.P.M.: 960

MAX. SPHERES 17 mm
 IMP. PATT. NO. 444A329
 CASE PATT. NO.
 180A041 UPPER (ALL)
 180A044 LOWER (411)
 180A081 LOWER (412 & 413)
 MIN. IMP. DIA. 330 mm

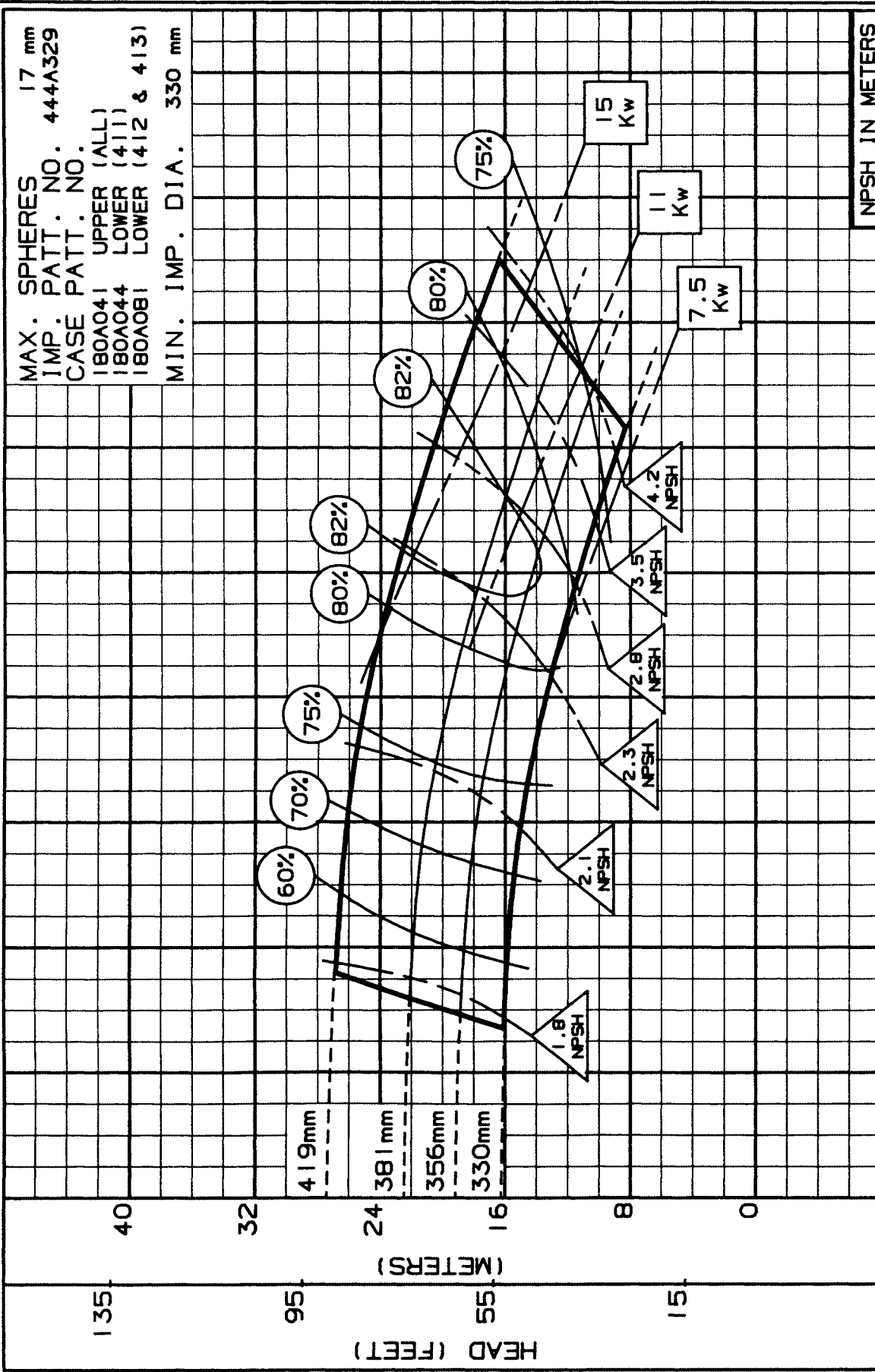

M ³ /HR	0	40	80	120	160	200	240	280	320	360
L/S	0	15	30	45	60	75	90	100	120	140
U.S. GPM	0	200	400	600	800	1000	1200	1400	1600	1800

DRAWN BY: *SPZ* APPROVED BY: DL DATE: 7-90 PC-144789M

SIZE: 6X8X11 TYPE: 410 IMPELLER: ENCLOSED R.P.M.: 1440

MAX. SPHERES 25 mm
IMP. PATT. NO. 444A327
CASE PATT. NO.
180A045 UPPER (ALL)
180A046 LOWER (411)
180A082 LOWER (412 & 413)
MIN. IMP. DIA. 184 mm

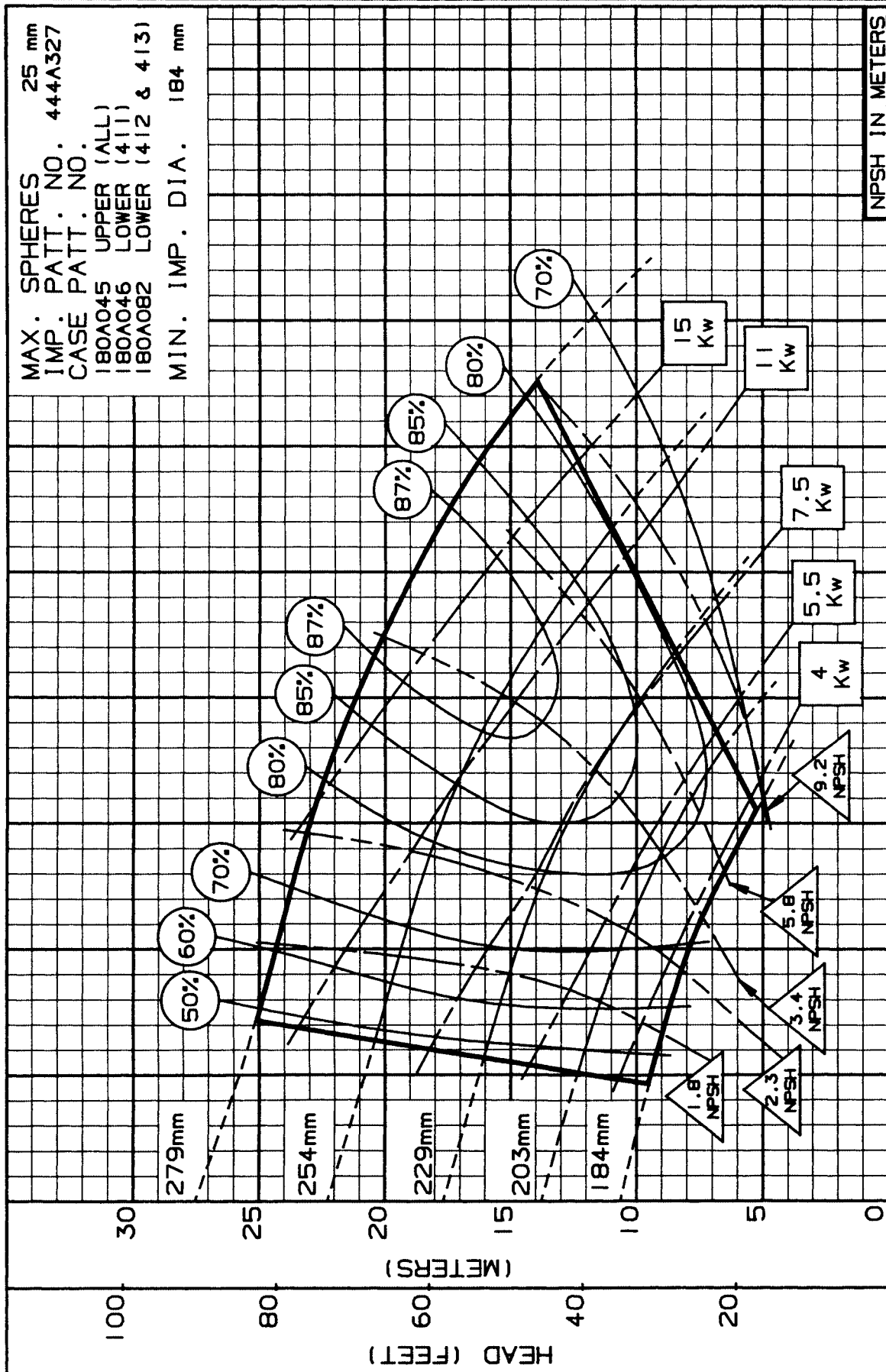

M ³ /HR	0	60	120	180	240	300	360	420	480	540
L/S	0	20	40	60	80	100	120	140	160	180
U.S. GPM	0	400	800	1200	1600	2000	2400	2800	3200	3600
NPSH IN METERS	0	0.6	1.2	1.8	2.4	3.0	3.6	4.2	4.8	5.4

DRAWN BY: *RAZ* APPROVED BY: DL DATE: 7-90 PC-117383M

6x8x11- 960 RPM
 ENCLOSED IMPELLER



SIZE: 6X8X11 TYPE: 410 IMPELLER: ENCLOSED R.P.M.: 960

MAX. SPHERES 25 mm
 IMP. PATT. NO. 444A327
 CASE PATT. NO.
 180A045 UPPER (ALL)
 180A046 LOWER (411)
 180A082 LOWER (412 & 413)
 MIN. IMP. DIA. 184 mm

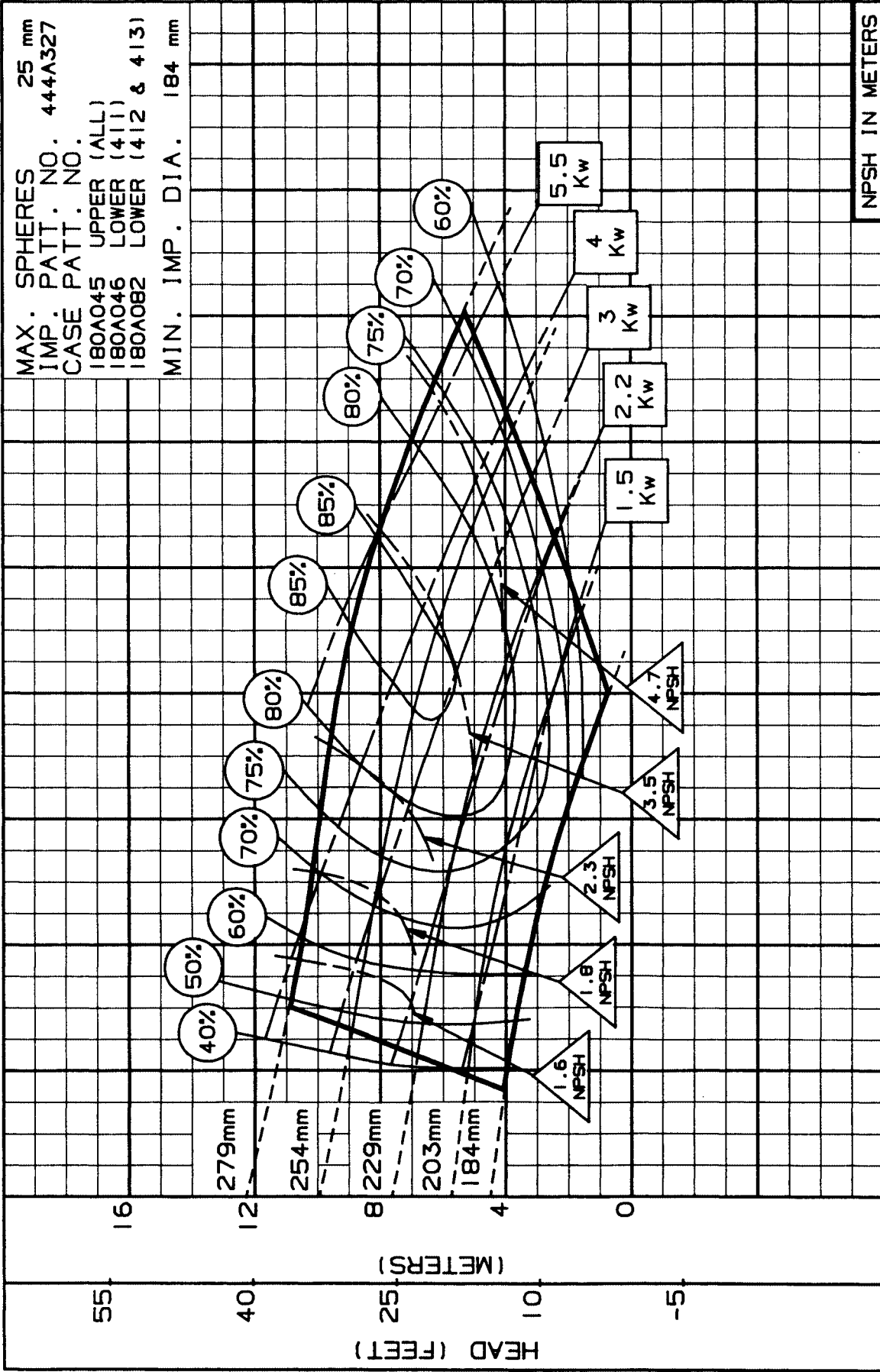

M ³ /HR	0	40	80	120	160	200	240	280	320	360
L/S	15	30	45	60	75	90	100	1200	1400	
U.S. GPM	200	400	600	800	1000	1200	1400			
NPSH IN METERS										

DRAWN BY: *RAK* APPROVED BY: DL DATE: 7-90 PC-117384M

SIZE: 6X8X15 TYPE: 410 IMPELLER: ENCLOSED R.P.M.: 1475

MAX. SPHERES 24 mm
IMP. PATT. NO. 444A330
CASE PATT. NO.
180A047 UPPER (ALL)
180A048 LOWER (411)
180A083 LOWER (412 & 413)
MIN. IMP. DIA. 254 mm

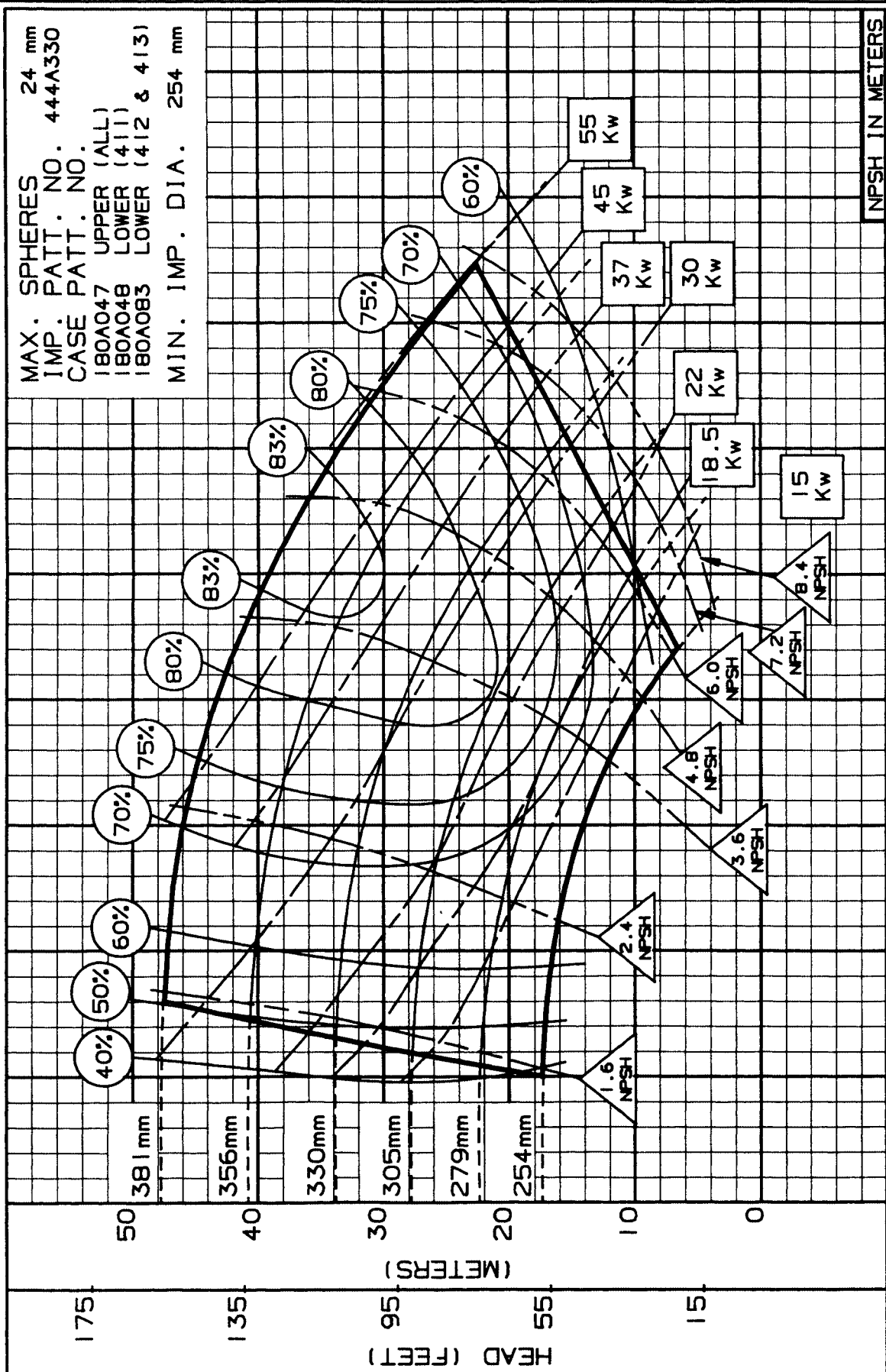

M ³ /HR	0	80	160	240	320	400	480	560	640	720
L/S	25	400	800	1200	1600	2000	2400	2800	3200	3600
U.S. GPM	400	800	1200	1600	2000	2400	2800	3200	3600	4000
NPSH IN METERS										

DRAWN BY: *RAC* APPROVED BY: *DL* DATE: 7-90 PC-117385M

6x8x15 - 960 RPM
 ENCLOSED IMPELLER

SIZE: 6X8X15 TYPE: 410 IMPELLER: ENCLOSED R.P.M.: 960

MAX. SPHERES 24 mm
 IMP. PATT. NO. 444A330
 CASE PATT. NO.
 180A047 UPPER (ALL)
 180A048 LOWER (411)
 180A083 LOWER (412 & 413)
 MIN. IMP. DIA. 254 mm

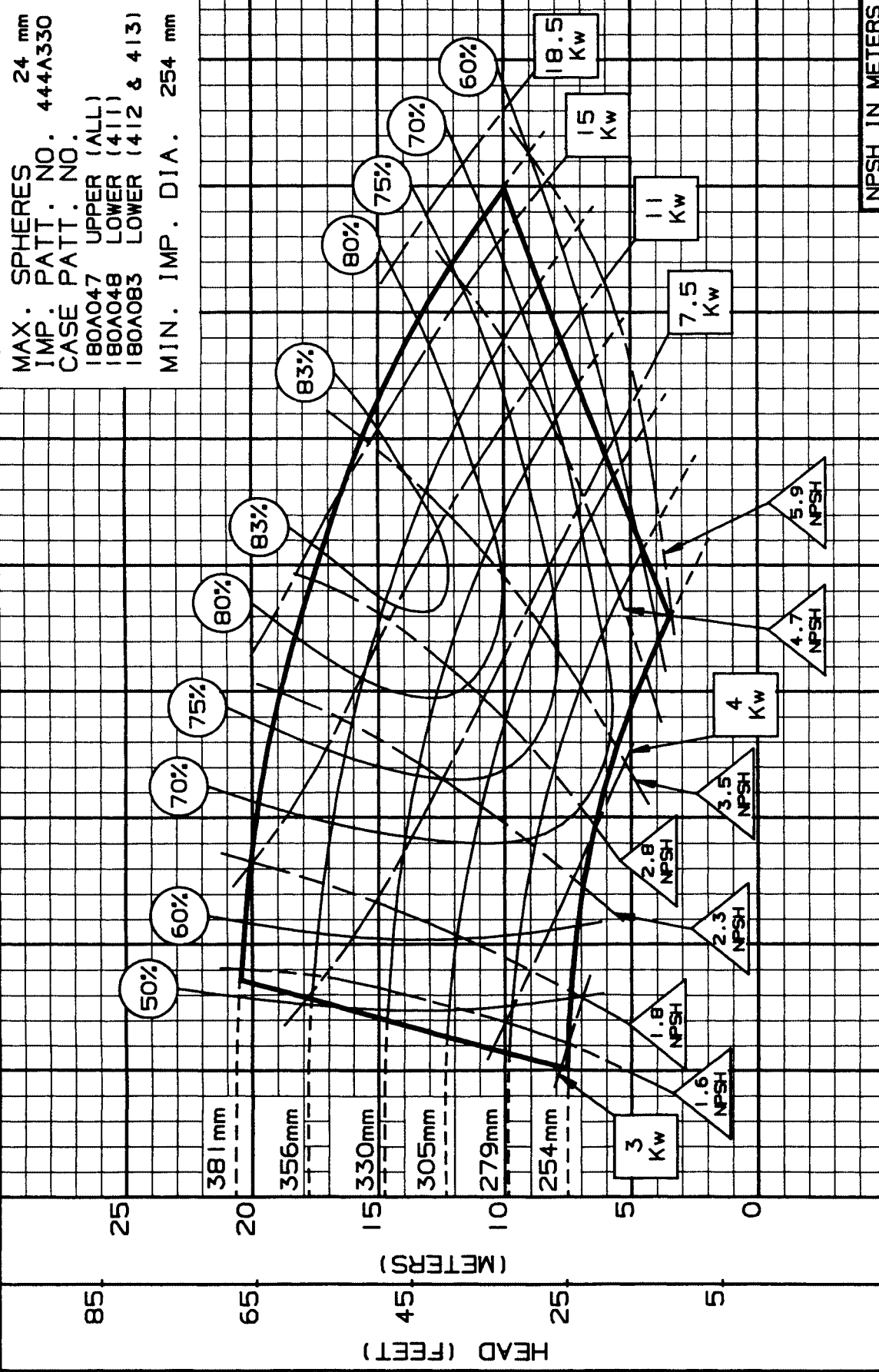

M ³ /HR	0	50	100	150	200	250	300	350	400	450
L/S	0	15	30	45	60	75	90	105	120	135
U.S. GPM	0	250	500	750	1000	1250	1500	1750	1750	1750
NPSH IN METERS										

DRAWN BY: *RAK* APPROVED BY: DL DATE: 7-90 PC-117386M



AURORA
Pentair Pump Group

6x8x18A - 1475 RPM
ENCLOSED IMPELLER

SECTION 410 (Metric 50Hz)
DATE **JULY 1994**
SUPERCEDES MARCH 1986

SIZE: 6X8X18A TYPE: 410 IMPELLER: ENCLOSED R.P.M.: 1475

MAX. SPHERES 25 mm
IMP. PATT. NO. 444A143
CASE PATT. NO.
180A217 UPPER (ALL)
180A218 LOWER (411)
180A260 LOWER (412 & 413)
MIN. IMP. DIA. 368 mm

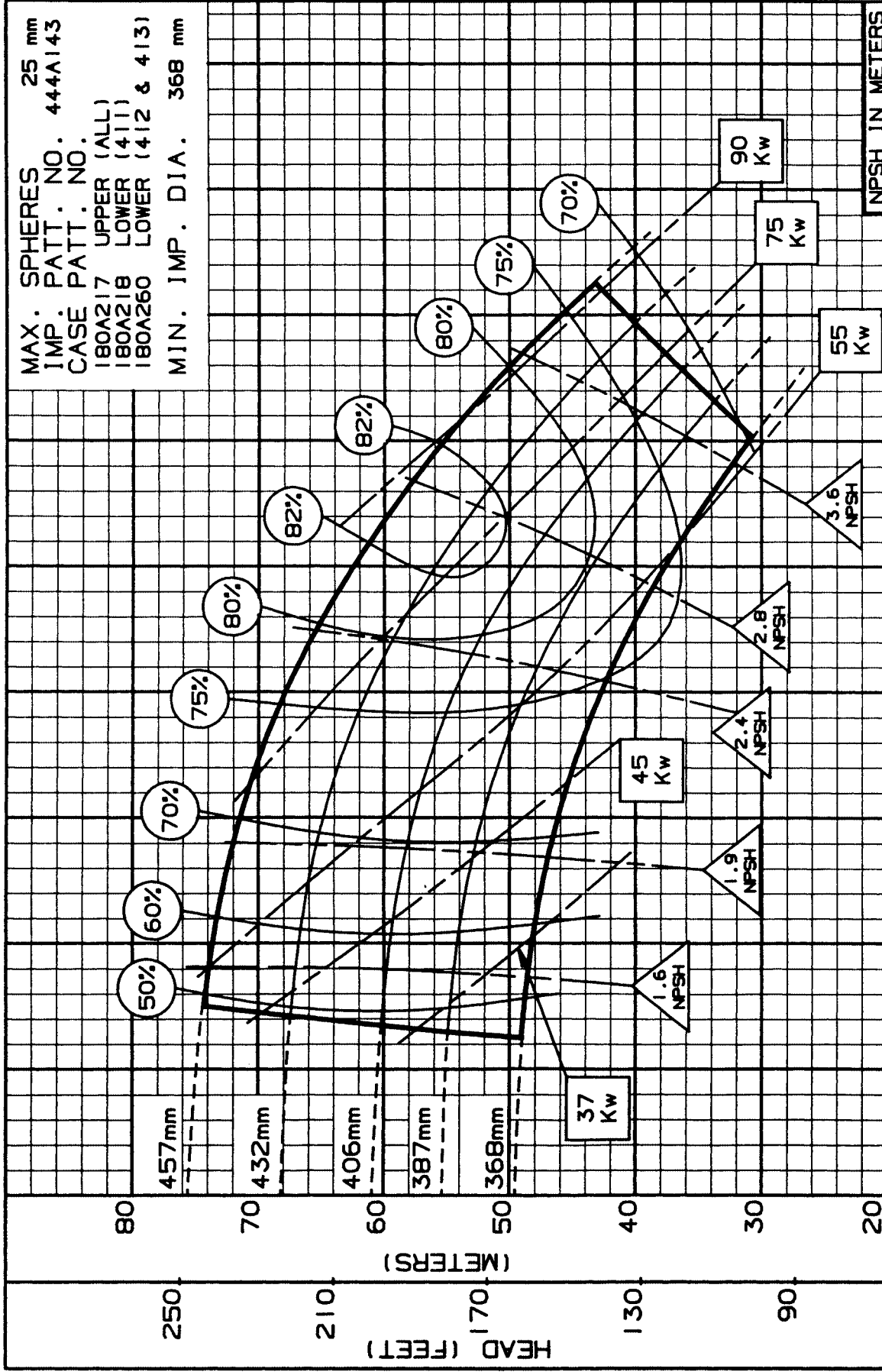

M ³ /HR	0	80	160	240	320	400	480	560	640	720
L/S	0	25	50	75	100	125	150	175	200	225
U.S. GPM	0	400	800	1200	1600	2000	2400	2800	3200	3600
NPSH IN METERS										

DRAWN BY: *AMC* APPROVED BY: DL DATE: 7-90 PC-125666M

6x8x18A - 980 RPM
 ENCLOSED IMPELLER



SIZE: 6X8X18A TYPE: 410 IMPELLER: ENCLOSED R.P.M.: 980

MAX. SPHERES 25 mm
 IMP. PATT. NO. 444A143
 CASE PATT. NO.
 180A217 UPPER (ALL)
 180A218 LOWER (411)
 180A260 LOWER (412 & 413)
 MIN. IMP. DIA. 368 mm

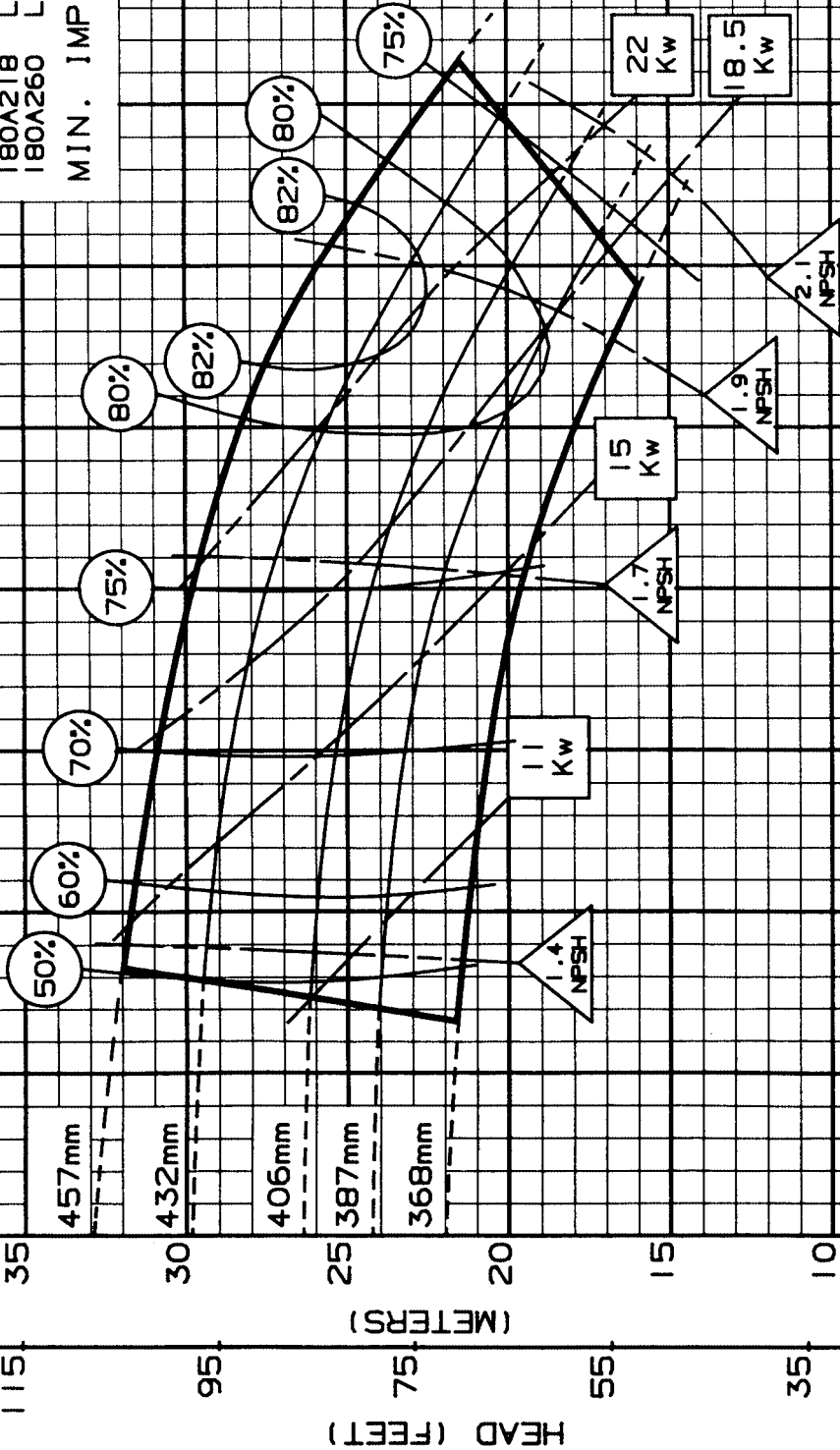

DRAWN BY: *SK* APPROVED BY: *DL* DATE: 7-90 PC-125667M

SIZE: 6X8X18B TYPE: 410 IMPELLER: ENCLOSED R.P.M.: 1475

MAX. SPHERES 25 mm
IMP. PATT. NO. 444A181
CASE PATT. NO.
180A217 UPPER (ALL)
180A218 LOWER (411)
180A260 LOWER (412 & 413)
MIN. IMP. DIA. 394 mm

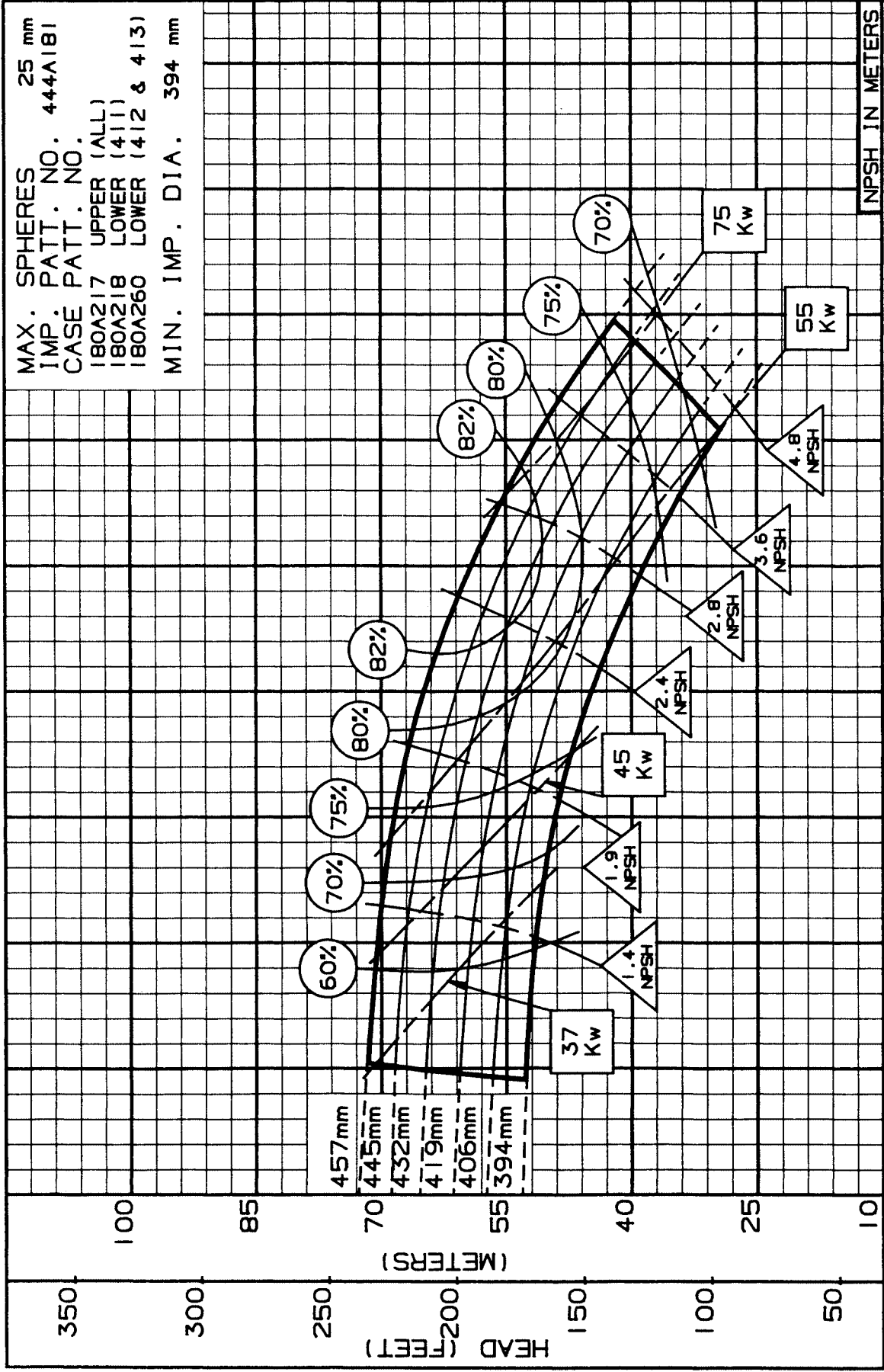

M ³ /HR	0	75	150	225	300	375	450	525	600	675
L/S	0	25	50	75	100	125	150	175	200	225
U.S. GPM	0	400	800	1200	1600	2000	2400	2800		
NPSH IN METERS										

DRAWN BY: *AMC* APPROVED BY: *DL* DATE: 7-90 PC-125668M

6x8x18B - 960 RPM

ENCLOSED IMPELLER



Pentair Pump Group

SIZE: 6X8X18B TYPE: 410 IMPELLER: ENCLOSED R.P.M.: 960

MAX. SPHERES 25 mm
 IMP. PATT. NO. 444A181
 CASE PATT. NO.
 180A217 UPPER (ALL)
 180A218 LOWER (411)
 180A260 LOWER (412 & 413)
 MIN. IMP. DIA. 394 mm

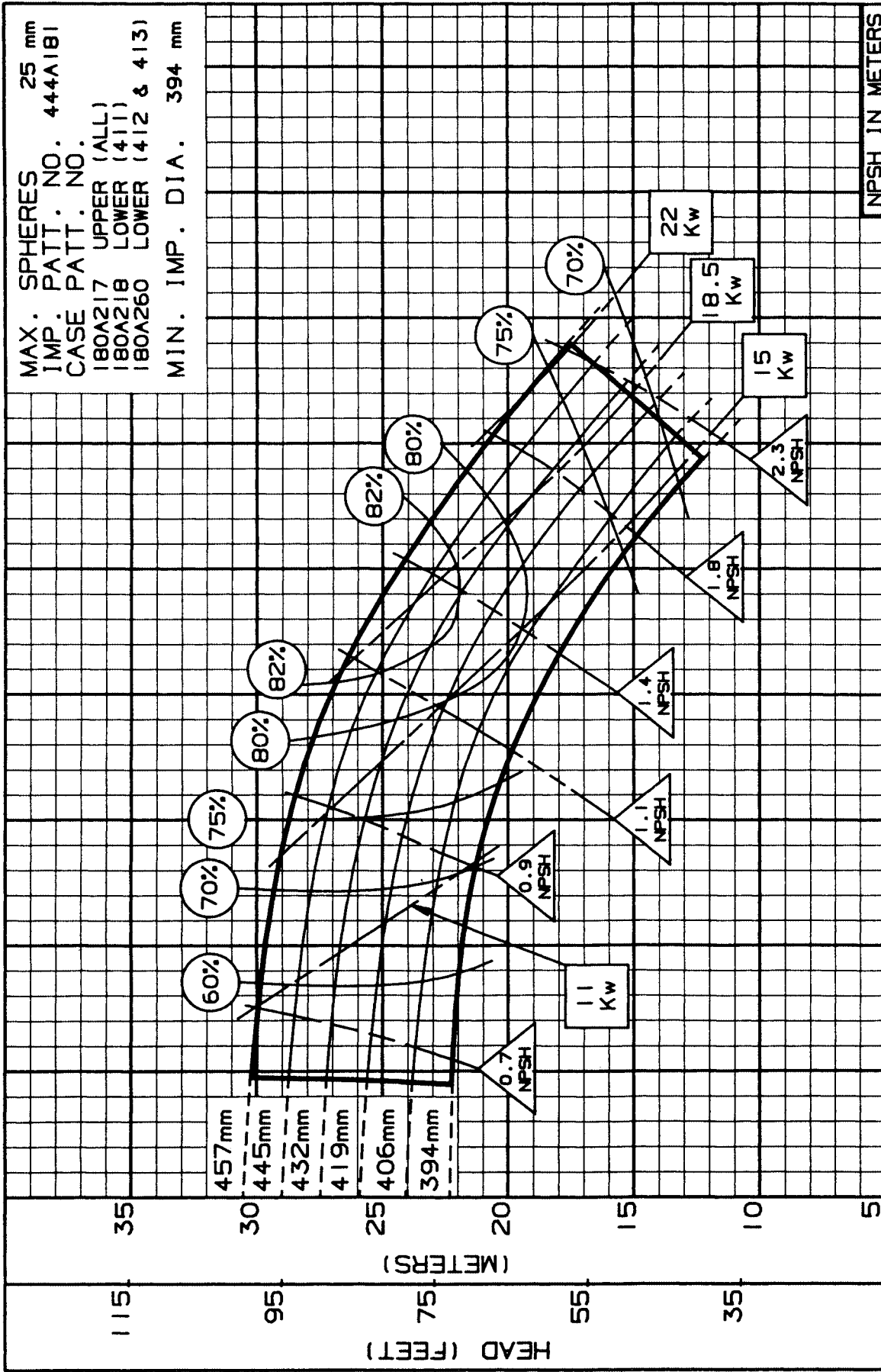

M ³ /HR	0	50	100	150	200	250	300	350	400	450
L/S	0	15	30	45	60	75	90	105	120	135
U.S. GPM	0	250	500	750	1000	1250	1500	1750	2000	2250
NPSH IN METERS	0	0.7	0.9	1.1	1.4	1.8	2.3	2.8	3.3	3.8
Power (Kw)	0	11	15	18.5	22	26	30	34	38	42

DRAWN BY: *RAK* APPROVED BY: *DL* DATE: 7-90 PC-125669M

SIZE: 6X8X18C TYPE: 410 IMPELLER: ENCLOSED R.P.M.: 1475

MAX. SPHERES 25 mm
IMP. PATT. NO. 444A183
CASE PATT. NO.
180A217 UPPER (ALL)
180A218 LOWER (411)
180A260 LOWER (412 & 413)
MIN. IMP. DIA. 394 mm

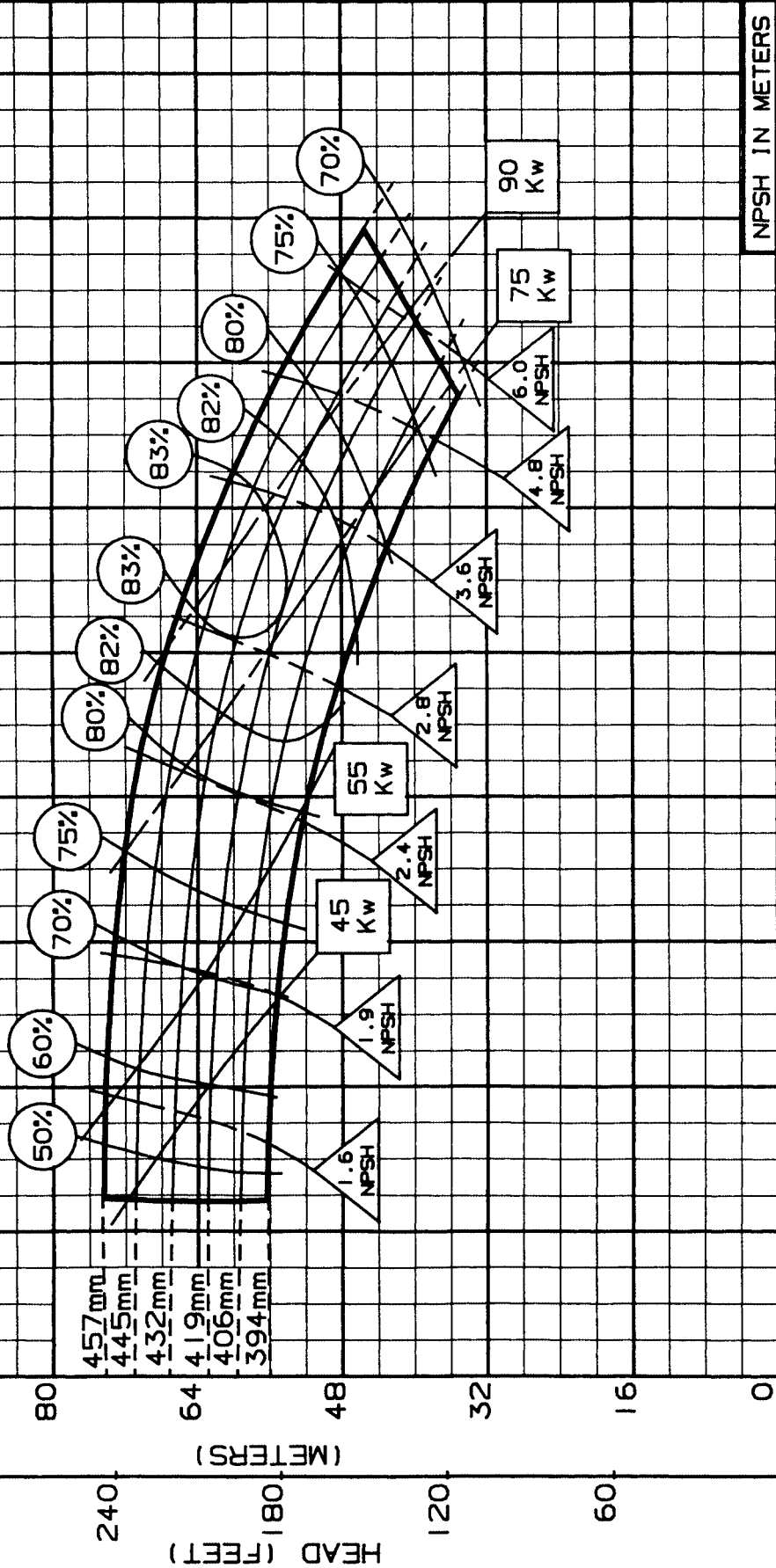

M ³ /HR	0	80	160	240	320	400	480	560	640	720
L/S	0	25	50	75	100	125	150	175	200	2800
U.S. GPM	0	400	800	1200	1600	2000	2400	2800	3200	3600
NPSH IN METERS										
DRAWN BY: <i>RAC</i> APPROVED BY: <i>DL</i> DATE: 7-90 PC-125670M										

6x8x18C - 960 RPM
 ENCLOSED IMPELLER



SIZE: 6X8X18C TYPE: 410 IMPELLER: ENCLOSED R.P.M.: 960

MAX. SPHERES 25 mm
 IMP. PATT. NO. 444A183
 CASE PATT. NO.
 180A217 UPPER (ALL)
 180A218 LOWER (411)
 180A260 LOWER (412 & 413)
 MIN. IMP. DIA. 394 mm

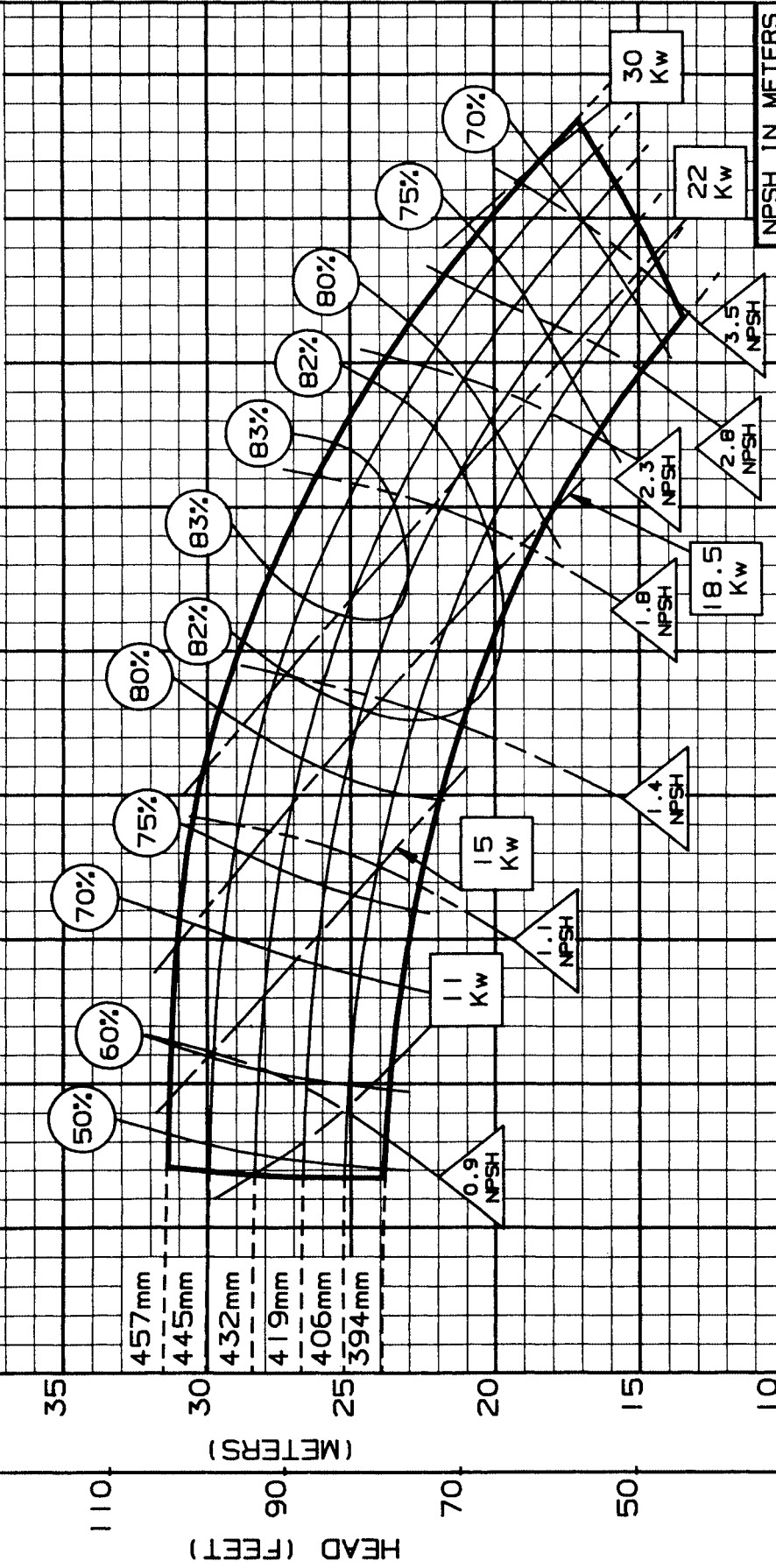

M ³ /HR	0	50	100	150	200	250	300	350	400	450
L/S	0	15	30	45	60	75	90	105	120	120
U.S. GPM	0	250	500	750	1000	1250	1500	1750	2000	2250
NPSH IN METERS										

DRAWN BY: *RAK* APPROVED BY: DL DATE: 7-90 PC-125671M

SIZE: 6X8X20 TYPE: 410 IMPELLER: ENCLOSED R.P.M.: 1475

MAX. SPHERES 21 mm
IMP. PATT. NO. 444A331
CASE PATT. NO.
180A049 UPPER (ALL)
180A050 LOWER (411)
180A084 LOWER (412 & 413)
MIN. IMP. DIA. 368 mm

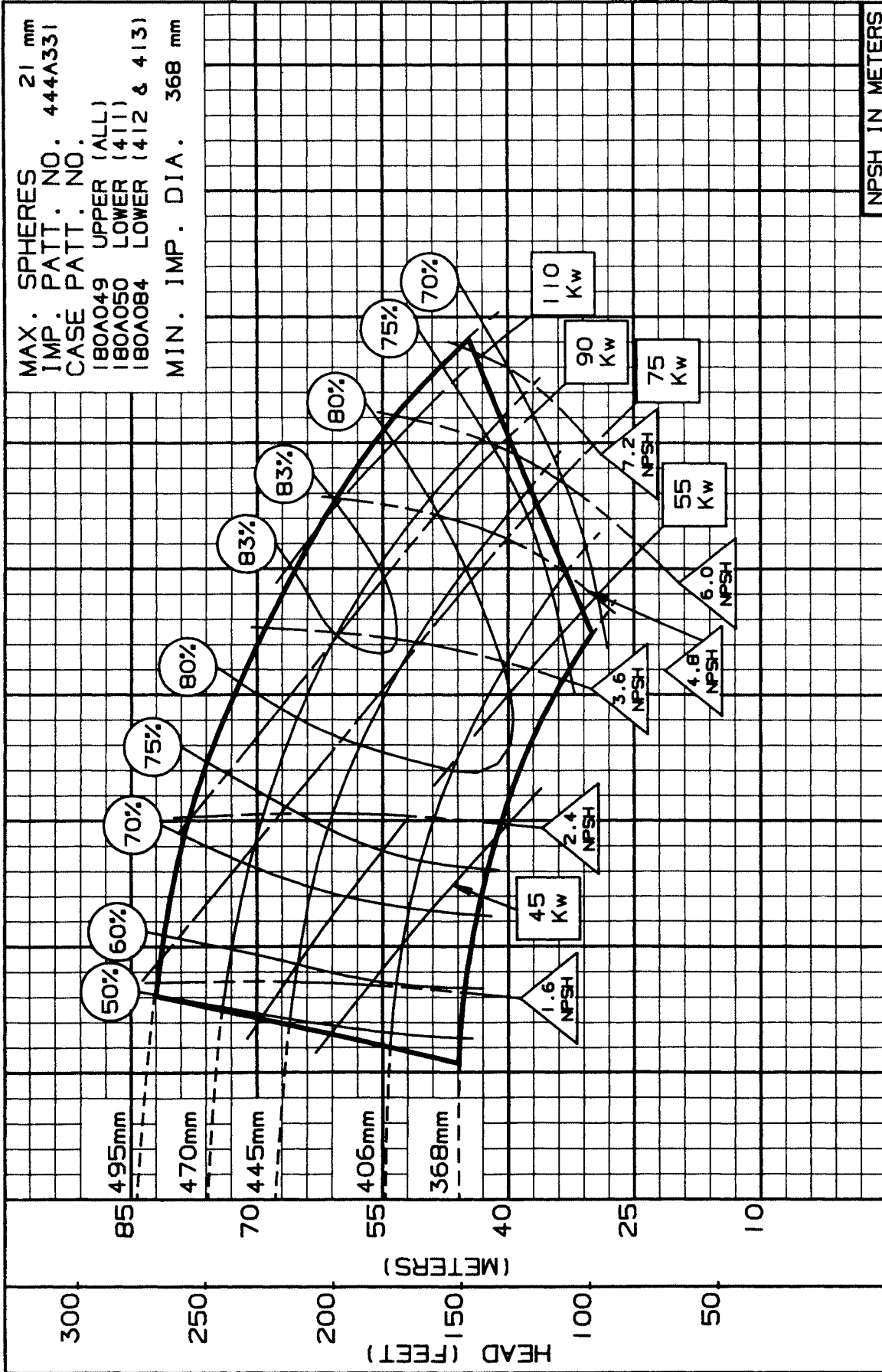

M 3/HR	0	100	200	300	400	500	600	700	800	900
L/S	40	80	120	160	200	250	300	350	400	450
U.S. GPM	500	1000	1500	2000	2500	3000	3500	4000	4500	5000

NPSH IN METERS: 0, 100, 200, 300, 400, 500, 600, 700, 800, 900
 DATE: 7-90
 APPROVED BY: *RAK*
 DRAWN BY: *RAK*
 PC-117389M

SECTION 410 (Metric 50Hz)

DATE JULY 1994

SUPERCEDES MARCH 1986

8x8x11B - 1440 RPM

ENCLOSED IMPELLER



Pentair Pump Group

SIZE: 8X8X11B TYPE: 410 IMPELLER: ENCLOSED R.P.M.: 1440

MAX. SPHERES 32 mm
 IMP. PATT. NO. 444A332
 CASE PATT. NO.
 180A045 UPPER (ALL)
 180A052 LOWER (411)
 180A085 LOWER (412 & 413)
 MIN. IMP. DIA. 184 mm

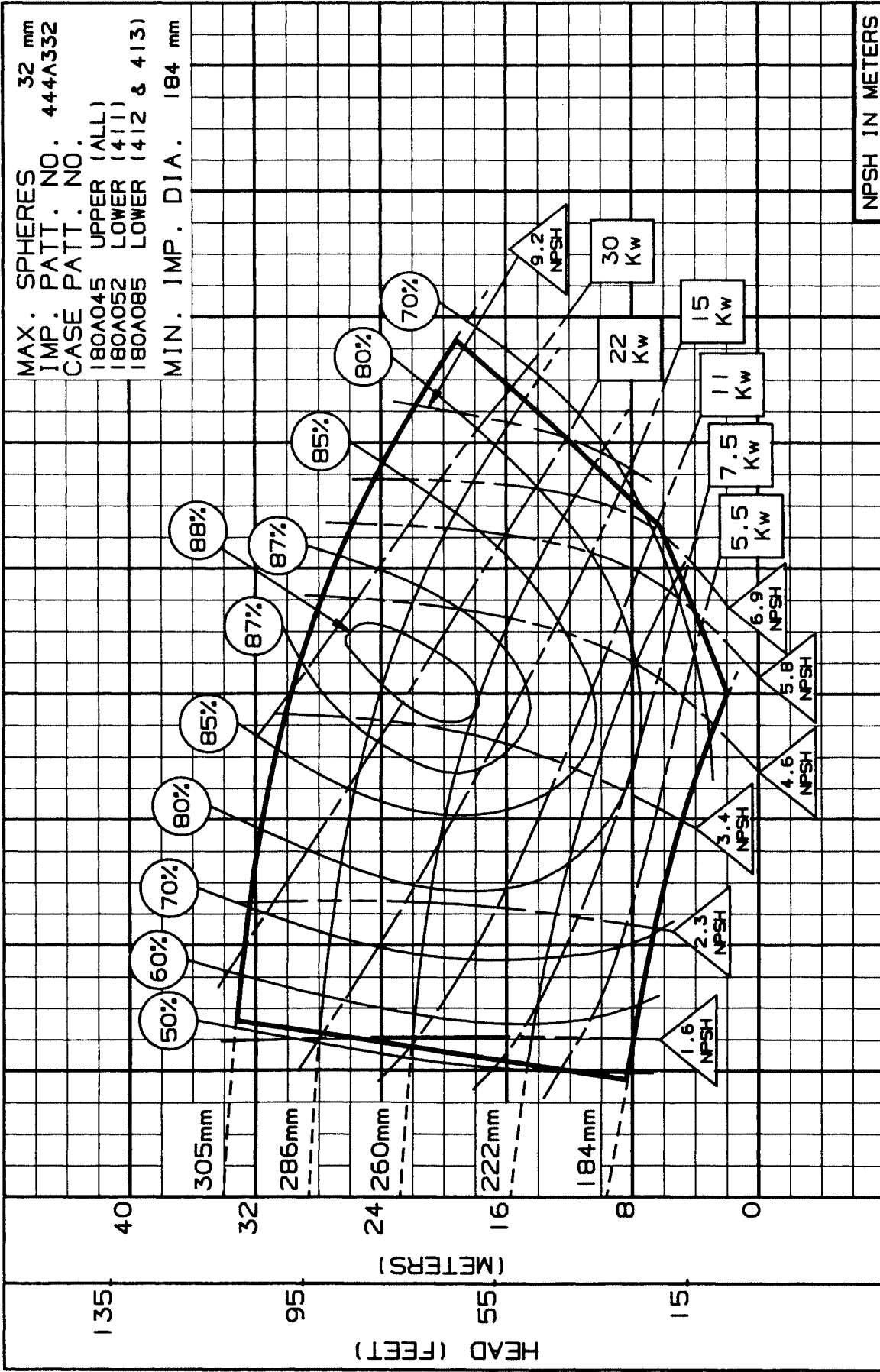

M ³ /HR	0	80	160	240	320	400	480	560	640	720
L/S	25	50	75	100	125	150	175	200	225	250
U.S. GPM	400	800	1200	1600	2000	2400	2800	3200	3600	4000
NPSH IN METERS										

DRAWN BY: *BAZ* APPROVED BY: *DL* DATE: 7-90 PC-131637M

SIZE: 8X8X11B TYPE: 410 IMPELLER: ENCLOSED R.P.M.: 960

MAX. SPHERES 32 mm
IMP. PATT. NO. 444A332
CASE PATT. NO.
180A045 UPPER (ALL)
180A052 LOWER (411)
180A085 LOWER (412 & 413)
MIN. IMP. DIA. 184 mm

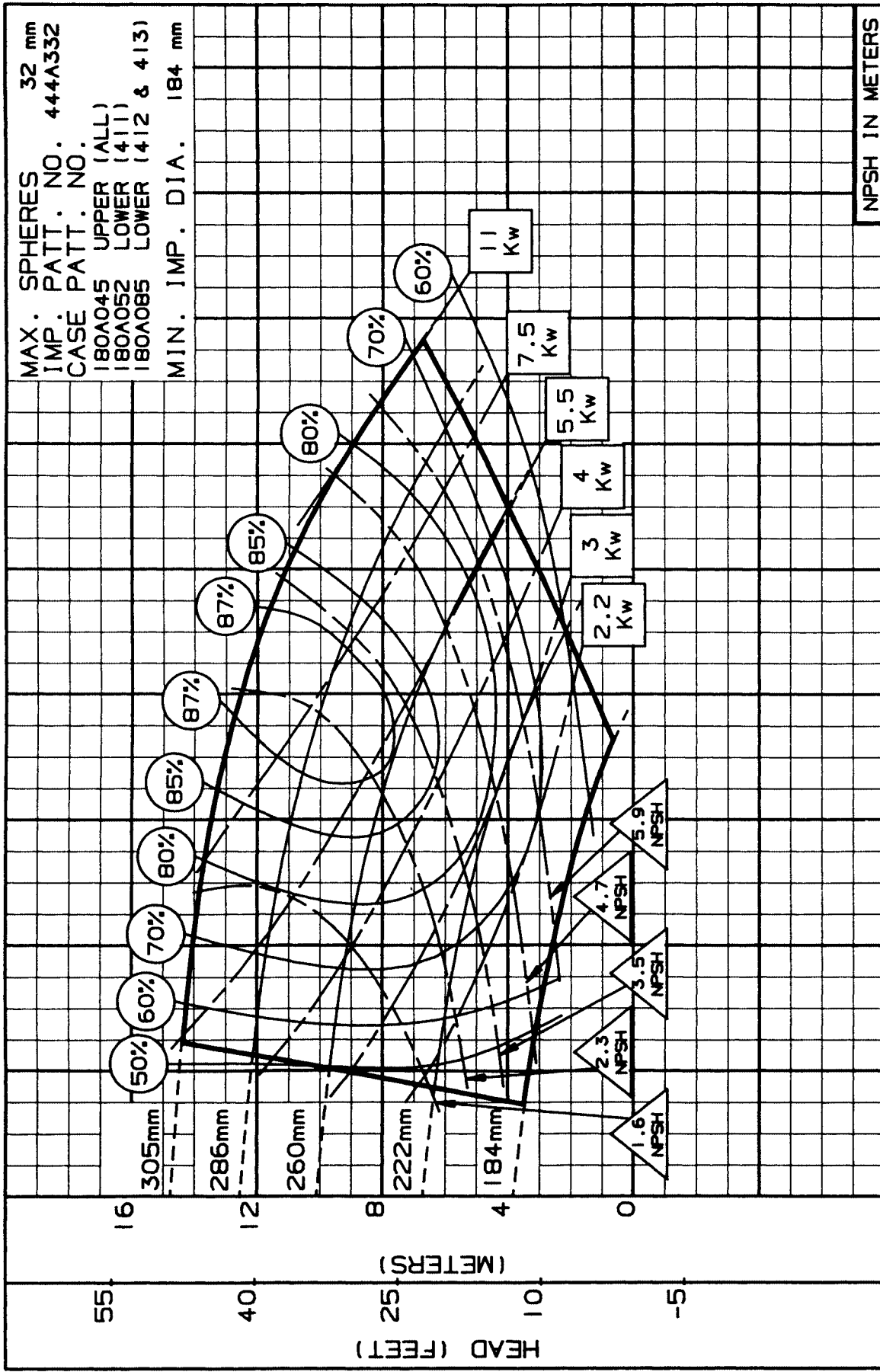

M ³ /HR	0	60	120	180	240	300	360	420	480	540
L/S	0	20	40	60	80	100	120	140	160	180
U.S. GPM	0	400	800	1200	1600	2000	2400	2800	3200	3600
NPSH IN METERS	0	0.5	1.0	1.5	2.0	2.5	3.0	3.5	4.0	4.5

DRAWN BY: *RAH* APPROVED BY: *DL* DATE: 7-90 PC-131638M

8x10x12 - 1440 RPM
 ENCLOSED IMPELLER



SIZE: 8X10X12 TYPE: 410 IMPELLER: ENCLOSED R.P.M.: 1440

MAX. SPHERES 24 mm
 IMP. PATT. NO. 444A330
 CASE PATT. NO.
 180A055 UPPER (ALL)
 180A056 LOWER (411)
 180A087 LOWER (412 & 413)
 MIN. IMP. DIA. 210 mm

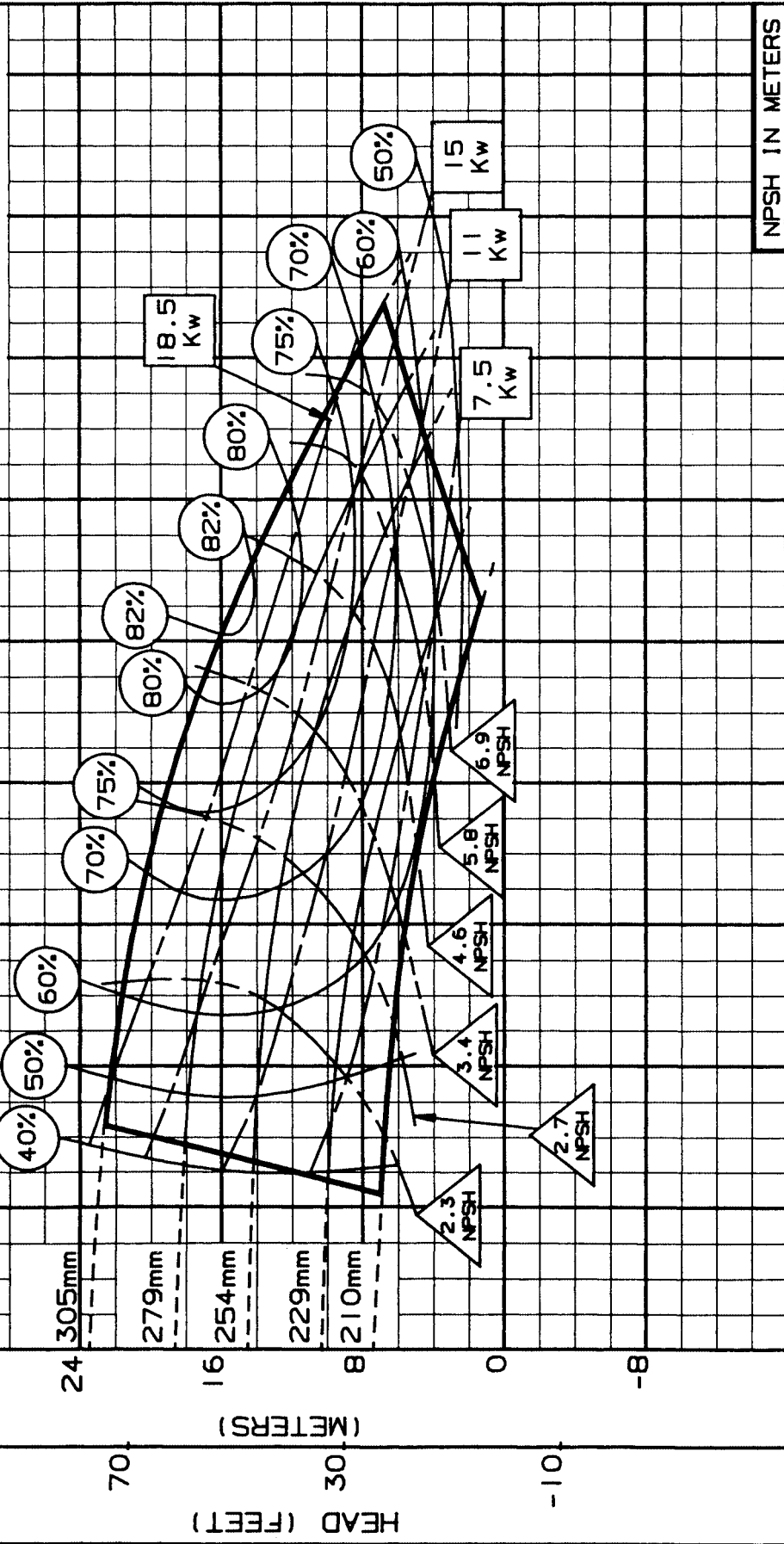

M ³ /HR	0	80	160	240	320	400	480	560	640	720
L/S	25	50	75	100	125	150	175	200	2400	2800
U.S. GPM	400	800	1200	1600	2000	2400	2800	2800	2800	2800
NPSH IN METERS										

DRAWN BY: *RAA* APPROVED BY: *DL* DATE: 7-90 PC-117393M

SIZE: 8X10X12 TYPE: 410 IMPELLER: ENCLOSED R.P.M.: 960

MAX. SPHERES 24 mm
IMP. PATT. NO. 444A330
CASE PATT. NO.
180A055 UPPER (ALL)
180A056 LOWER (411)
180A087 LOWER (412 & 413)
MIN. IMP. DIA. 210 mm

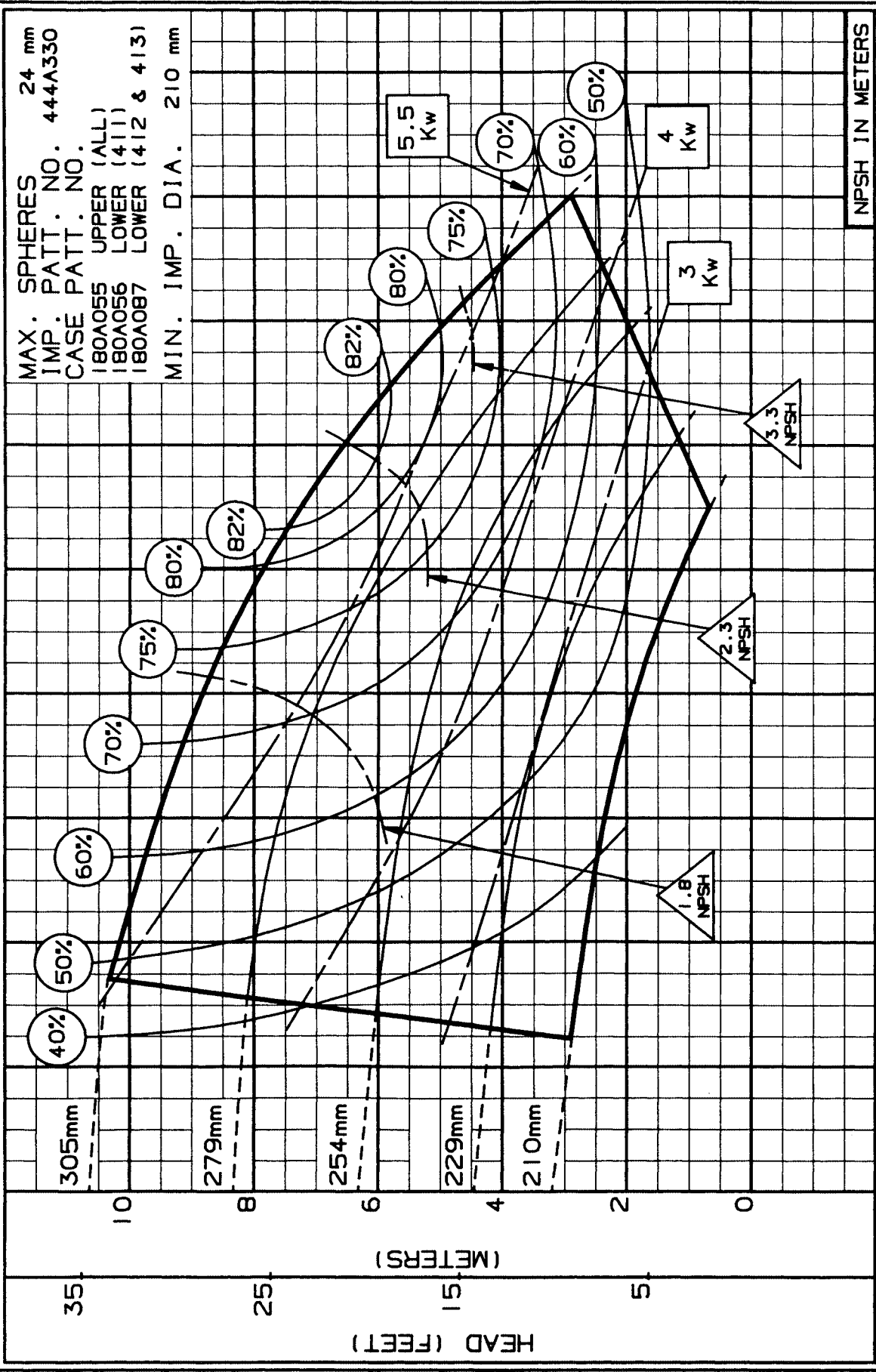

M ³ /HR	0	50	100	150	200	250	300	350	400	450
L/S	15	30	45	60	75	90	105	120	135	150
U.S. GPM	250	500	750	1000	1250	1500	1750			
NPSH IN METERS										
DRAWN BY: <i>RAZ</i> APPROVED BY: DL DATE: 7-90 PC-117394M										

SIZE: 8X10X12A TYPE: 410 IMPELLER: ENCLOSED R.P.M.: 1475

MAX. SPHERES 33 mm
 IMP. PATT. NO. 444A137
 CASE PATT. NO.
 180A055 UPPER (ALL)
 180A056 LOWER (411)
 180A087 LOWER (412 & 413)
 MIN. IMP. DIA. 286 mm

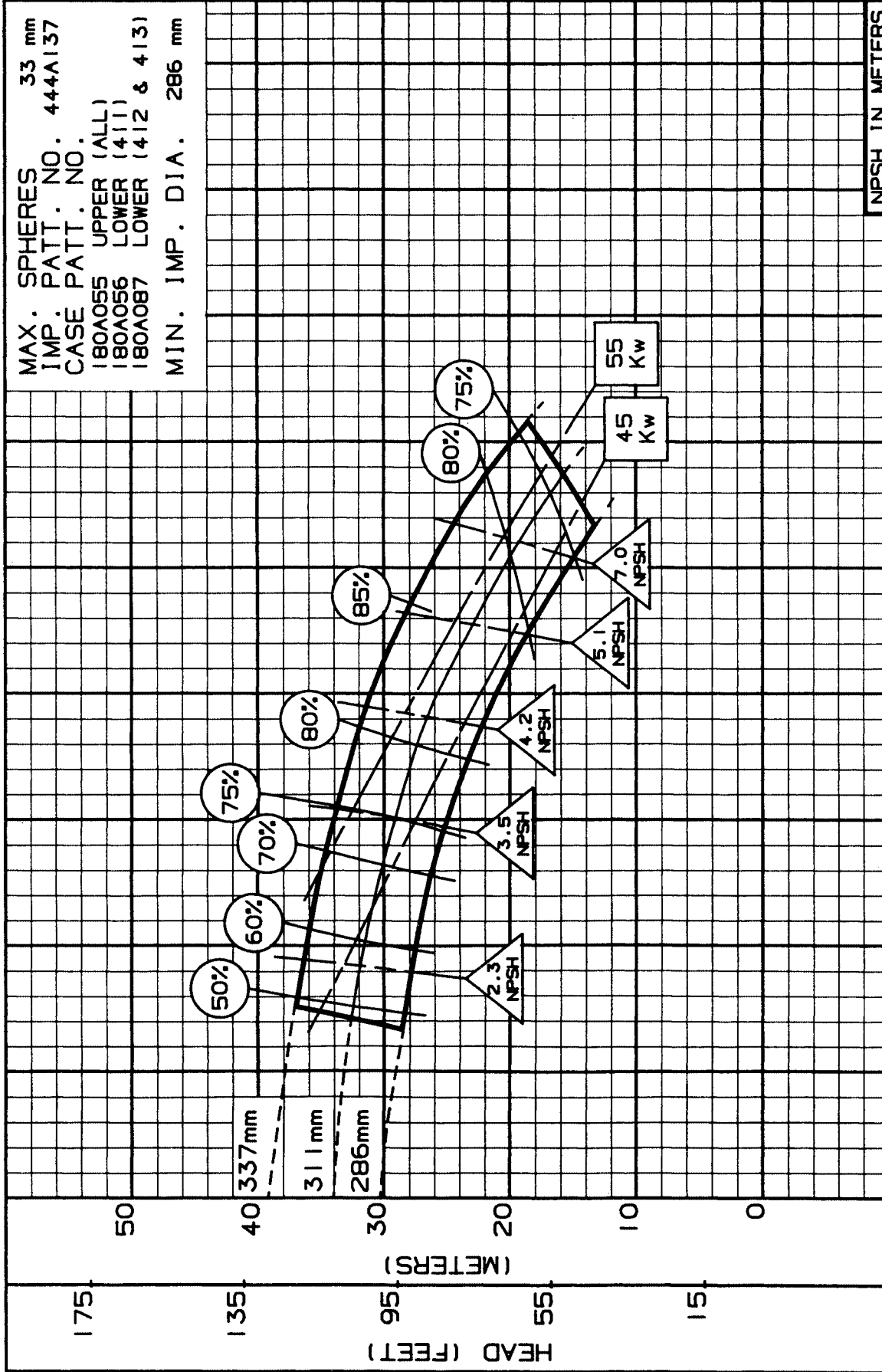

M ³ /HR	0	150	300	450	600	750	900	1050	1200	1350
L/S	0	50	100	150	200	250	300	350	400	450
U.S. GPM	0	750	1500	2250	3000	3750	4500	5250	6000	6750

NPSH IN METERS: 0, 10, 20, 30, 40, 50
 DRAWN BY: *Rak* APPROVED BY: *DL* DATE: 7-90 PC-14600M

SIZE: 8X10X12A TYPE: 410 IMPELLER: ENCLOSED R.P.M.: 980

MAX. SPHERES 33 mm
IMP. PATT. NO. 444A137
CASE PATT. NO.
180A055 UPPER (ALL)
180A056 LOWER (411)
180A087 LOWER (412 & 413)
MIN. IMP. DIA. 286 mm

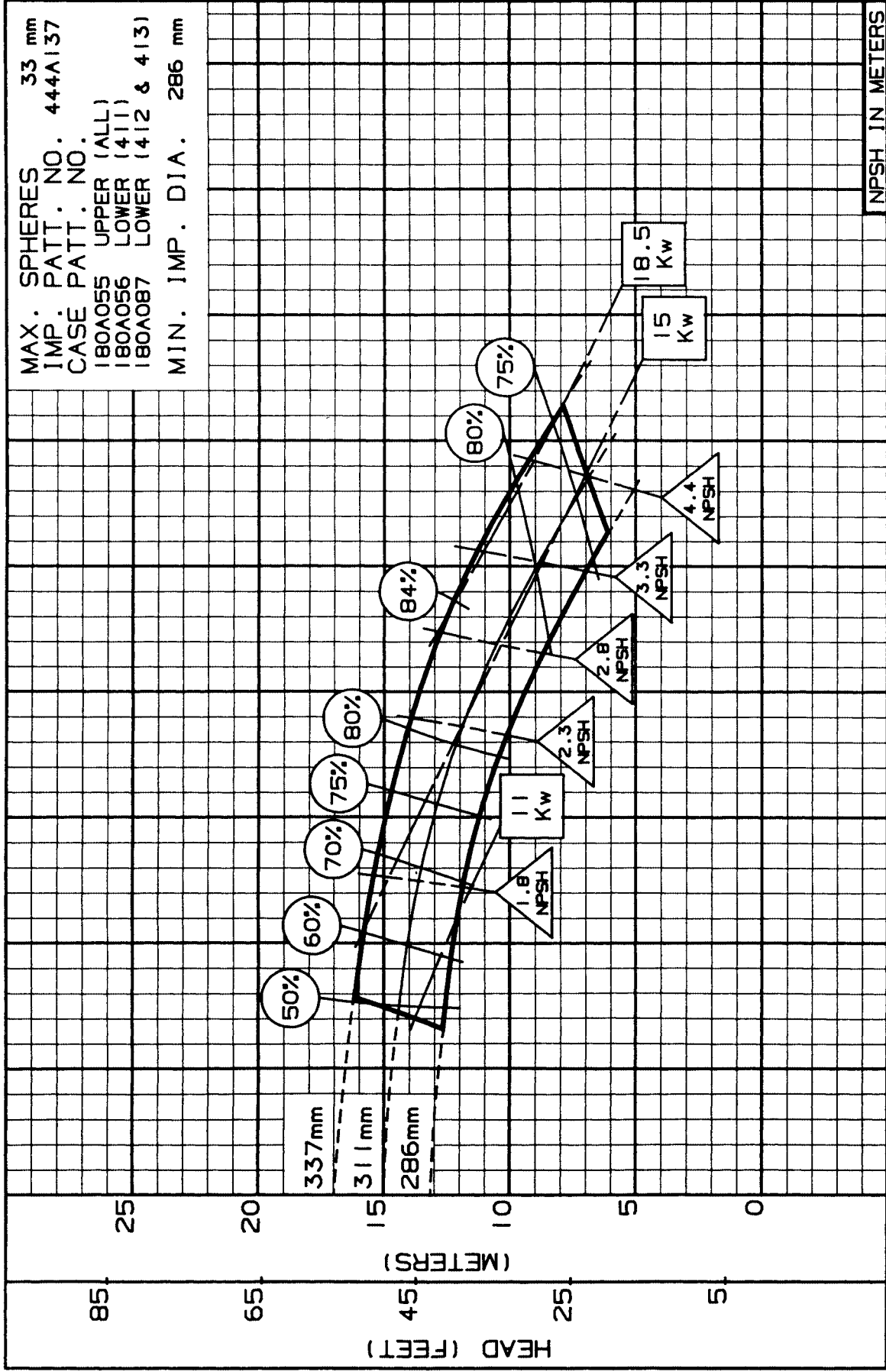

M ³ /HR	0	100	200	300	400	500	600	700	800	900
L/S	0	40	80	120	160	200	240	280	320	360
U.S. GPM	0	500	1000	1500	2000	2500	3000	3500	4000	4500
NPSH IN METERS										

DRAWN BY: *AP* APPROVED BY: DL DATE: 7-94 PC-145999M

8x10x15A - 1475 RPM
 ENCLOSED IMPELLER

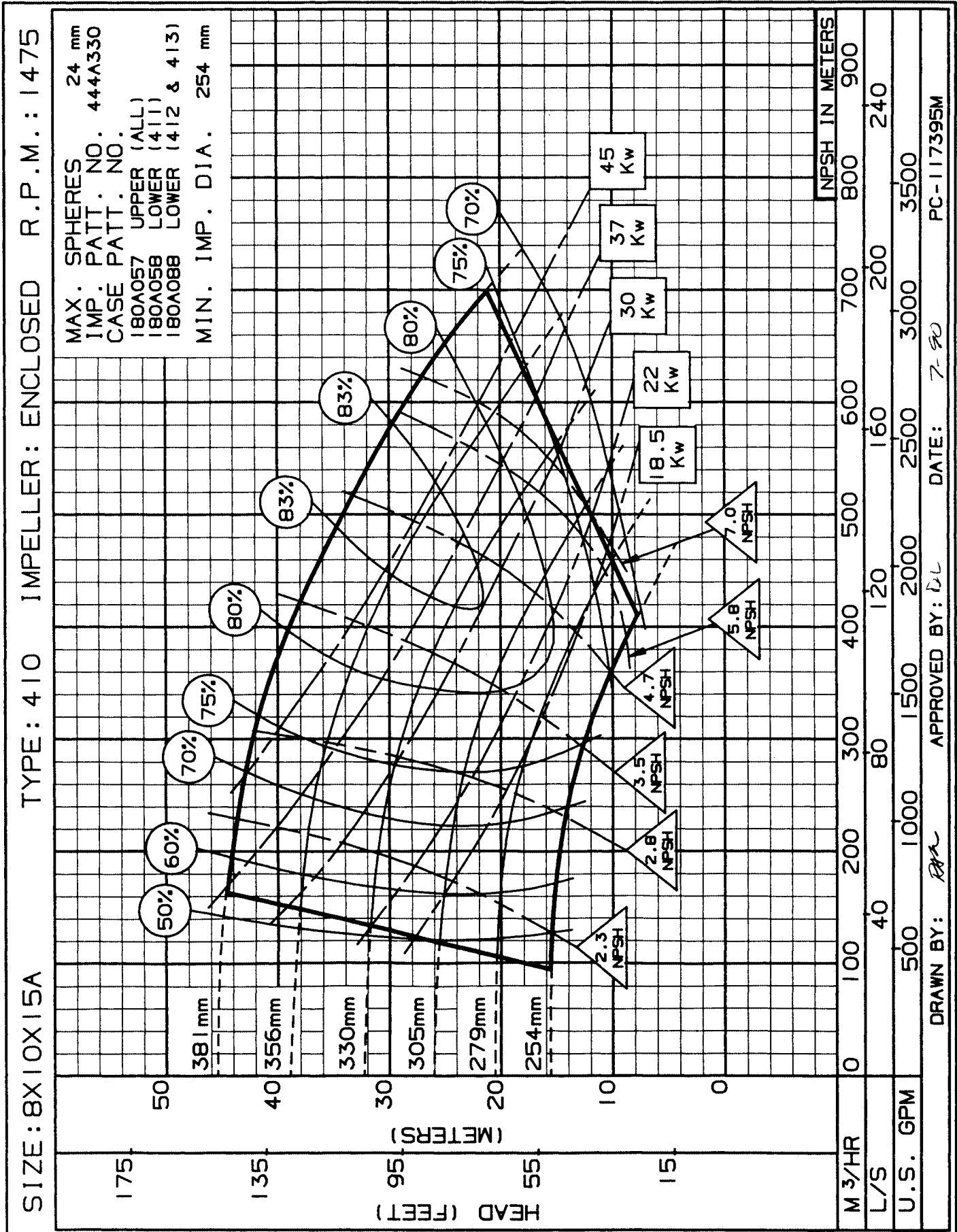

SIZE: 8X10X15A TYPE: 410 IMPELLER: ENCLOSED R.P.M.: 960

MAX. SPHERES 24 mm
IMP. PATT. NO. 444A330
CASE PATT. NO.
180A057 UPPER (ALL)
180A058 LOWER (411)
180A088 LOWER (412 & 413)
MIN. IMP. DIA. 254 mm

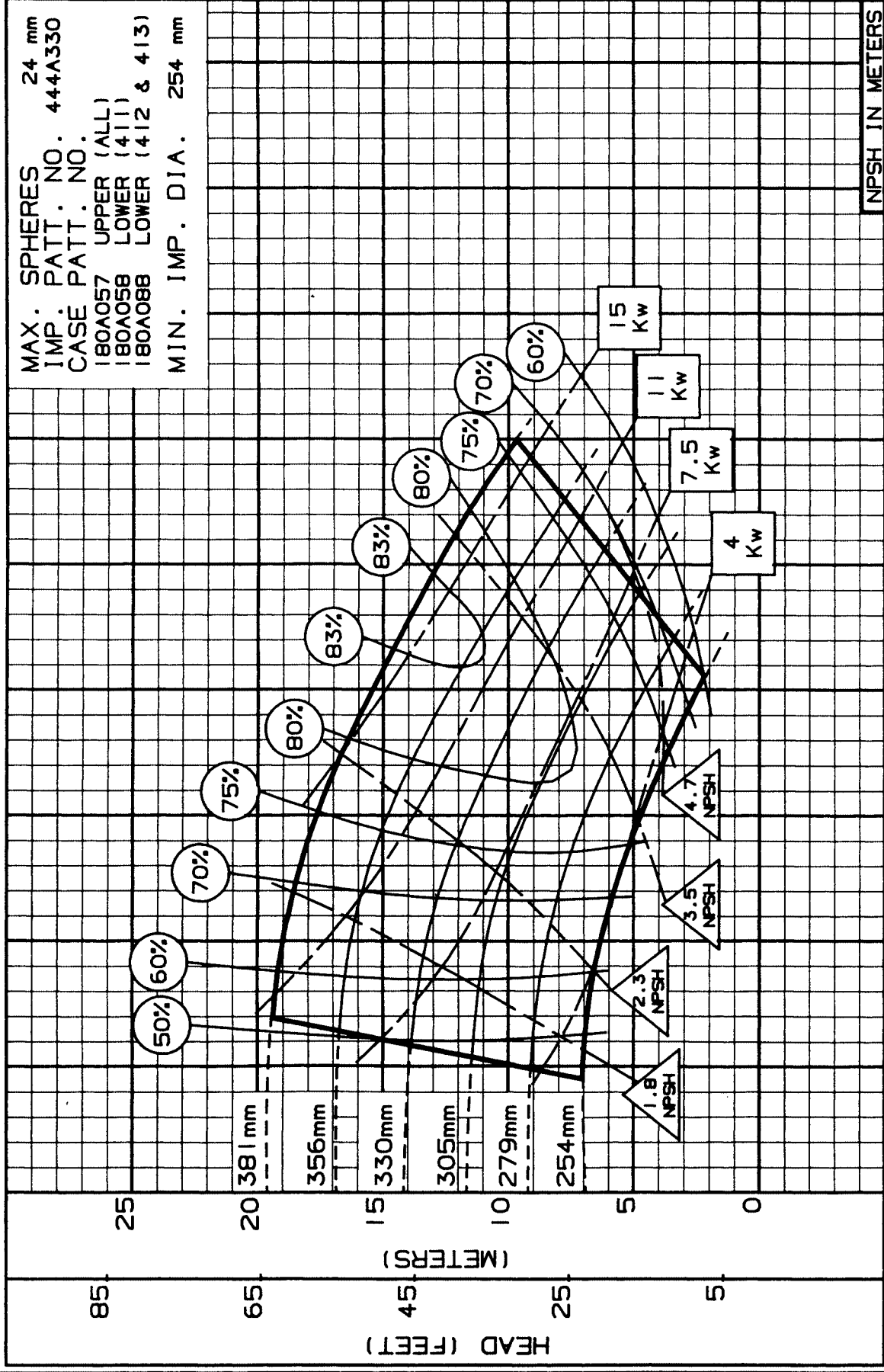

M ³ /HR	0	75	150	225	300	375	450	525	600	675
L/S	25	50	75	100	125	150	175	200	2400	2800
U.S. GPM	400	800	1200	1600	2000	2400	2800	3200	3600	4000
NPSH IN METERS										
	0	75	150	225	300	375	450	525	600	675

DRAWN BY: *APC* APPROVED BY: DC DATE: 7-90 PC-117396M

SECTION 410 (Metric 50Hz)
 DATE JULY 1994
 SUPERCEDES MARCH 1986

8x10x21 - 1475 RPM
 ENCLOSED IMPELLER

ap AURORA®
 Pentair Pump Group

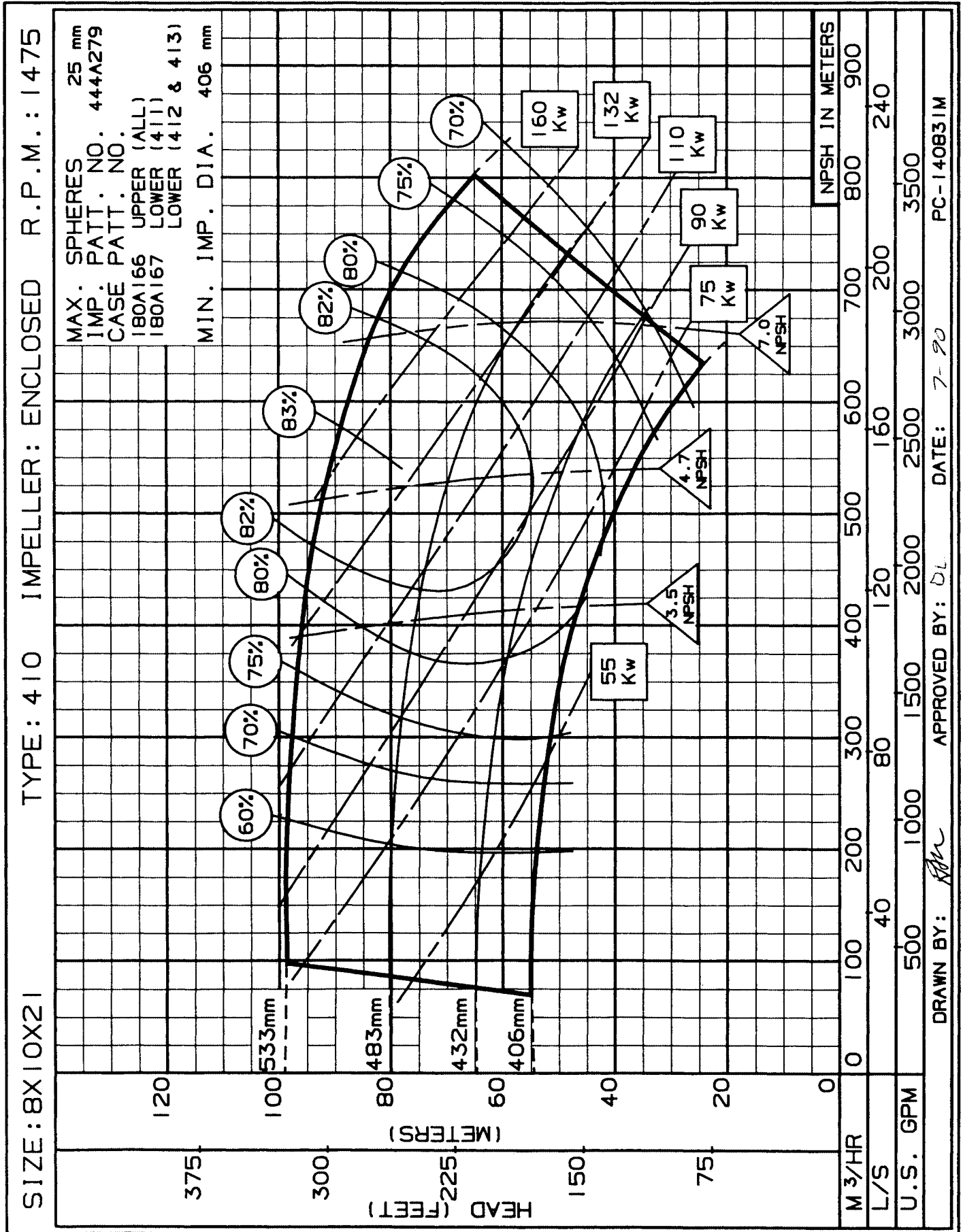

SIZE: 8X10X21 TYPE: 410 IMPELLER: ENCLOSED R.P.M.: 980

MAX. SPHERES 25 mm
IMP. PATT. NO. 444A279
CASE PATT. NO.
180A166 UPPER (ALL)
180A167 LOWER (411 & 413)
MIN. IMP. DIA. 406 mm

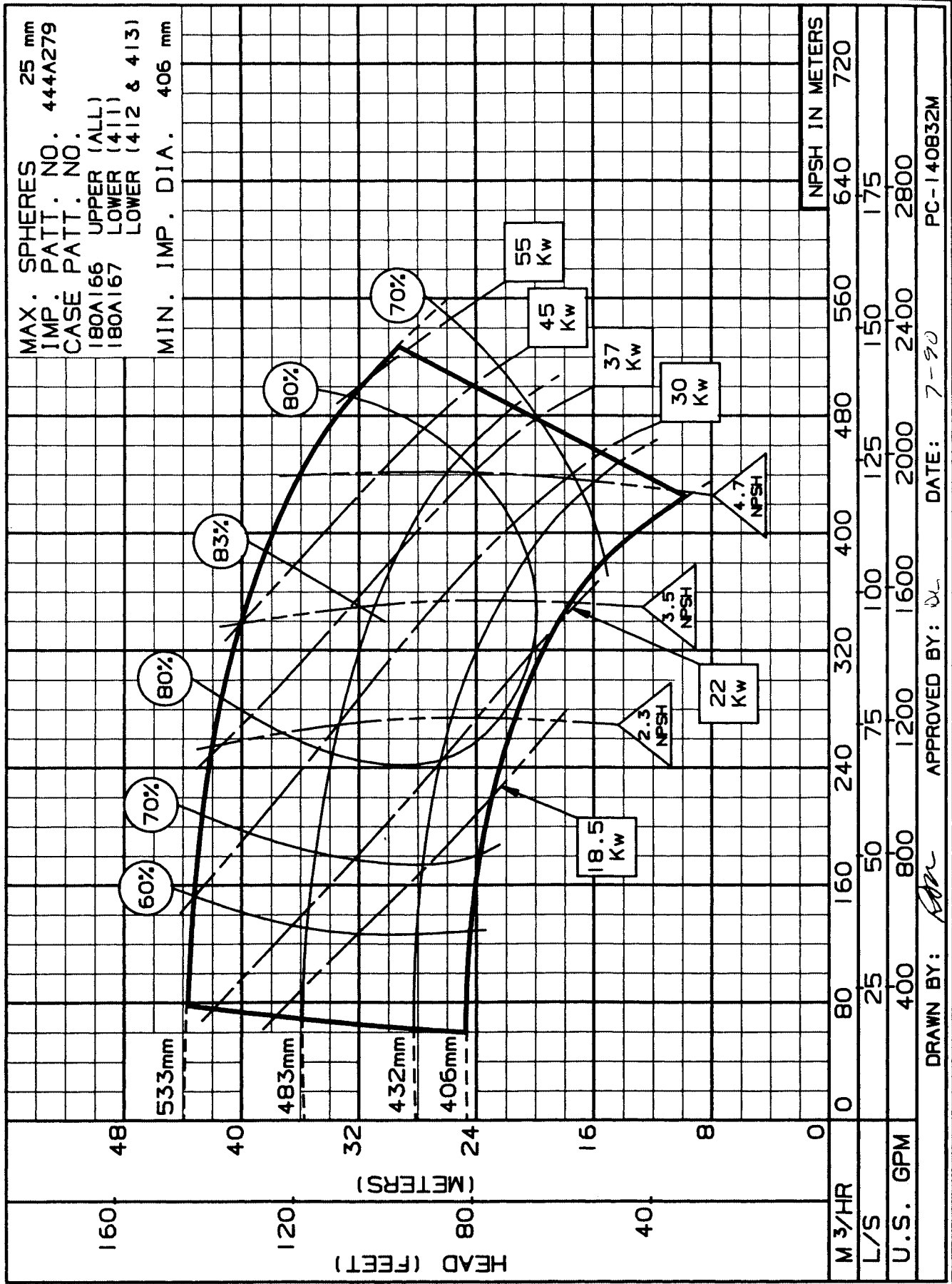

DRAWN BY: *[Signature]* APPROVED BY: *[Signature]* DATE: 7-90 PC-140832M

8x10x21A - 1475 RPM

ENCLOSED IMPELLER



Pentair Pump Group

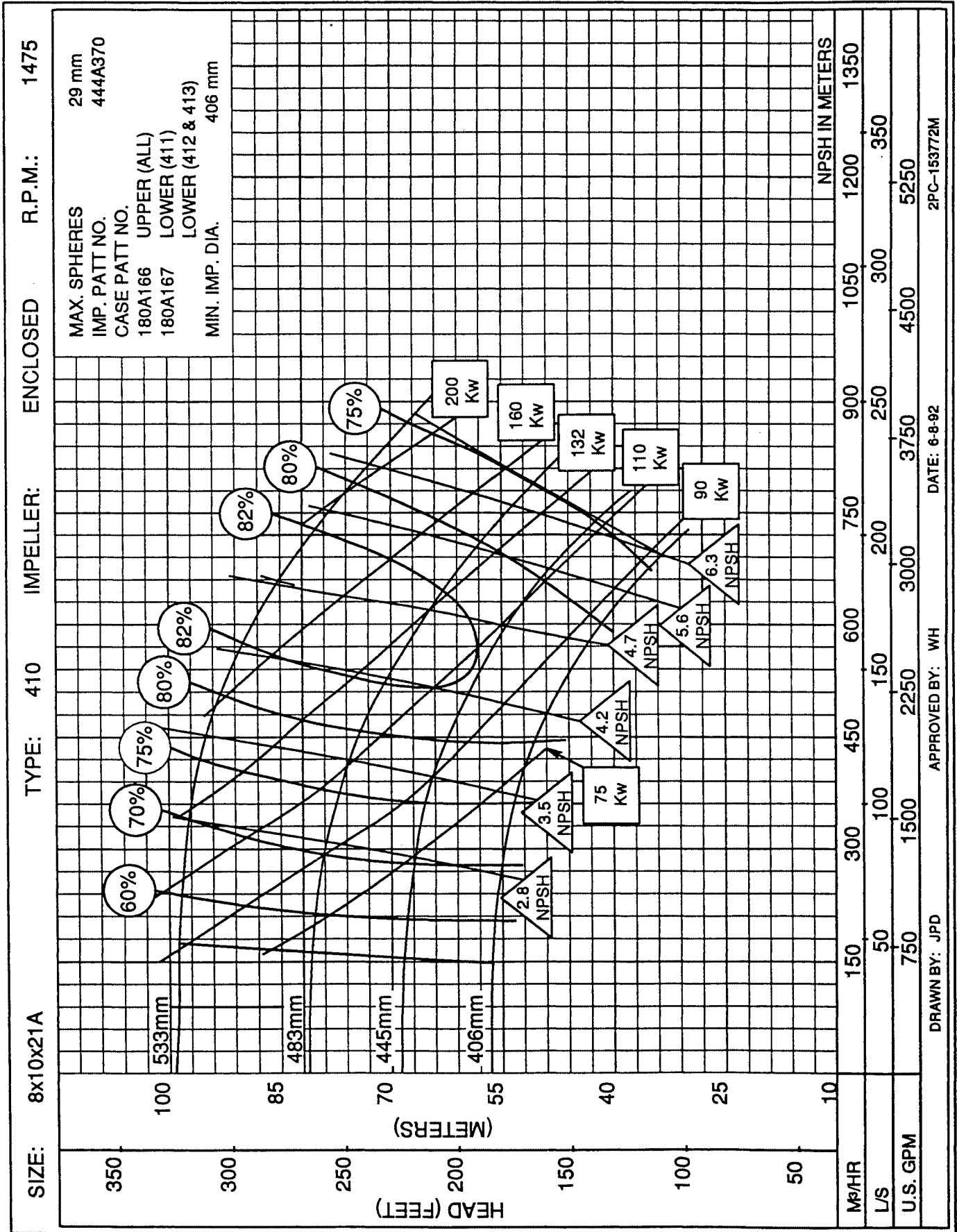

SIZE: **8x10x21A** TYPE: **410** IMPELLER: **ENCLOSED** R.P.M.: **980**

MAX. SPHERES
IMP. PATT NO. 29 mm
444A370
CASE PATT NO.
180A166 UPPER (ALL)
180A167 LOWER (411)
LOWER (412 & 413)
MIN. IMP. DIA. 406 mm

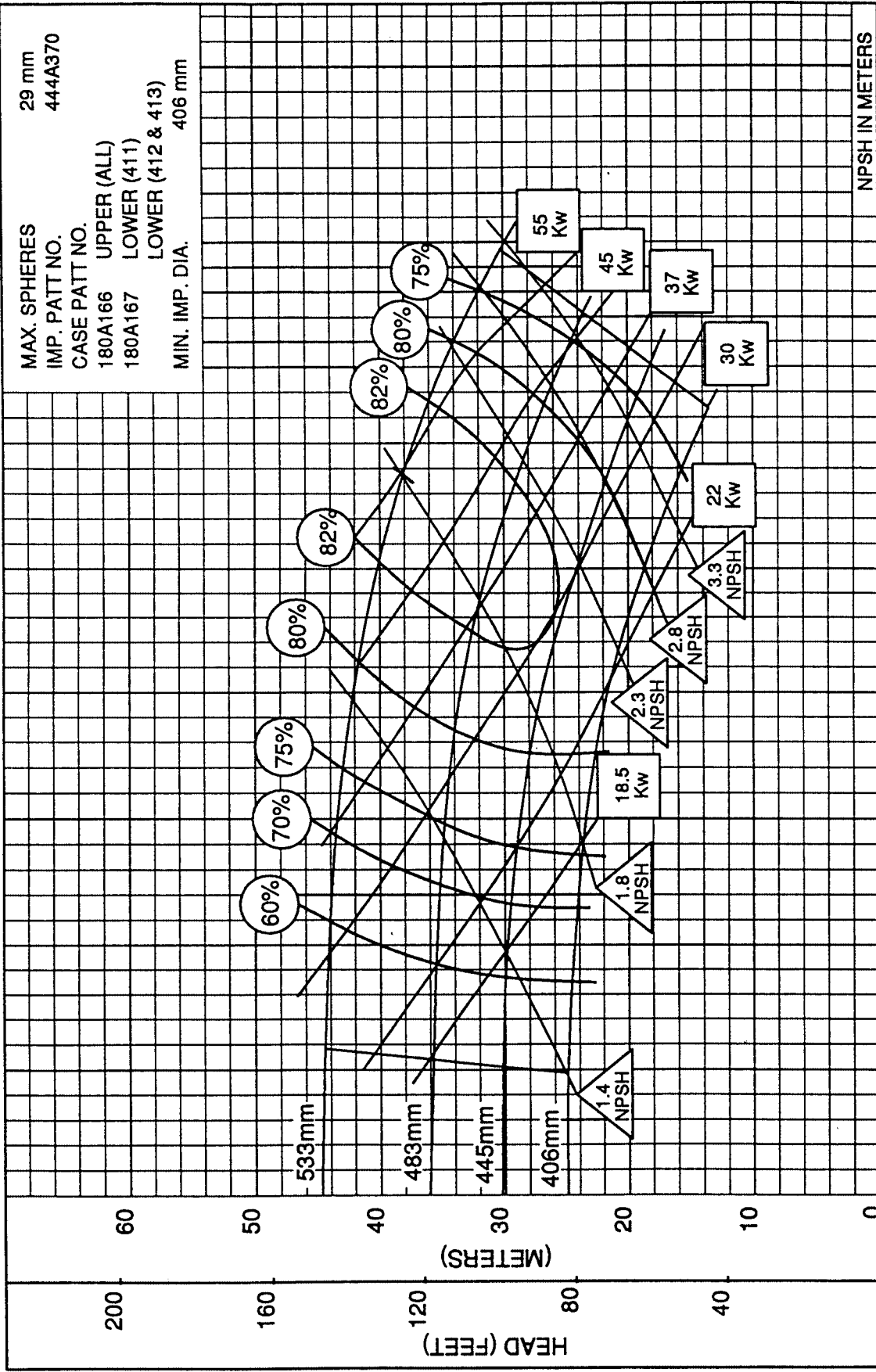

M ³ /HR	75	150	225	300	375	450	525	600	675
L/S	25	50	75	100	125	150	175	200	2400
U.S. GPM	400	800	1200	1600	2000	2400	2800	2800	2800
NPSH IN METERS									

DRAWN BY: JPD APPROVED BY: WH DATE: 6-8-92 2PC-15373M

SIZE: 10X12X12B TYPE: 410 IMPELLER: ENCLOSED R.P.M.: 1440

MAX. SPHERES 24 mm
 IMP. PATT. NO. 444A144
 CASE PATT. NO. 180A219 UPPER (ALL)
 180A220 LOWER (411)
 MIN. IMP. DIA. 251 mm

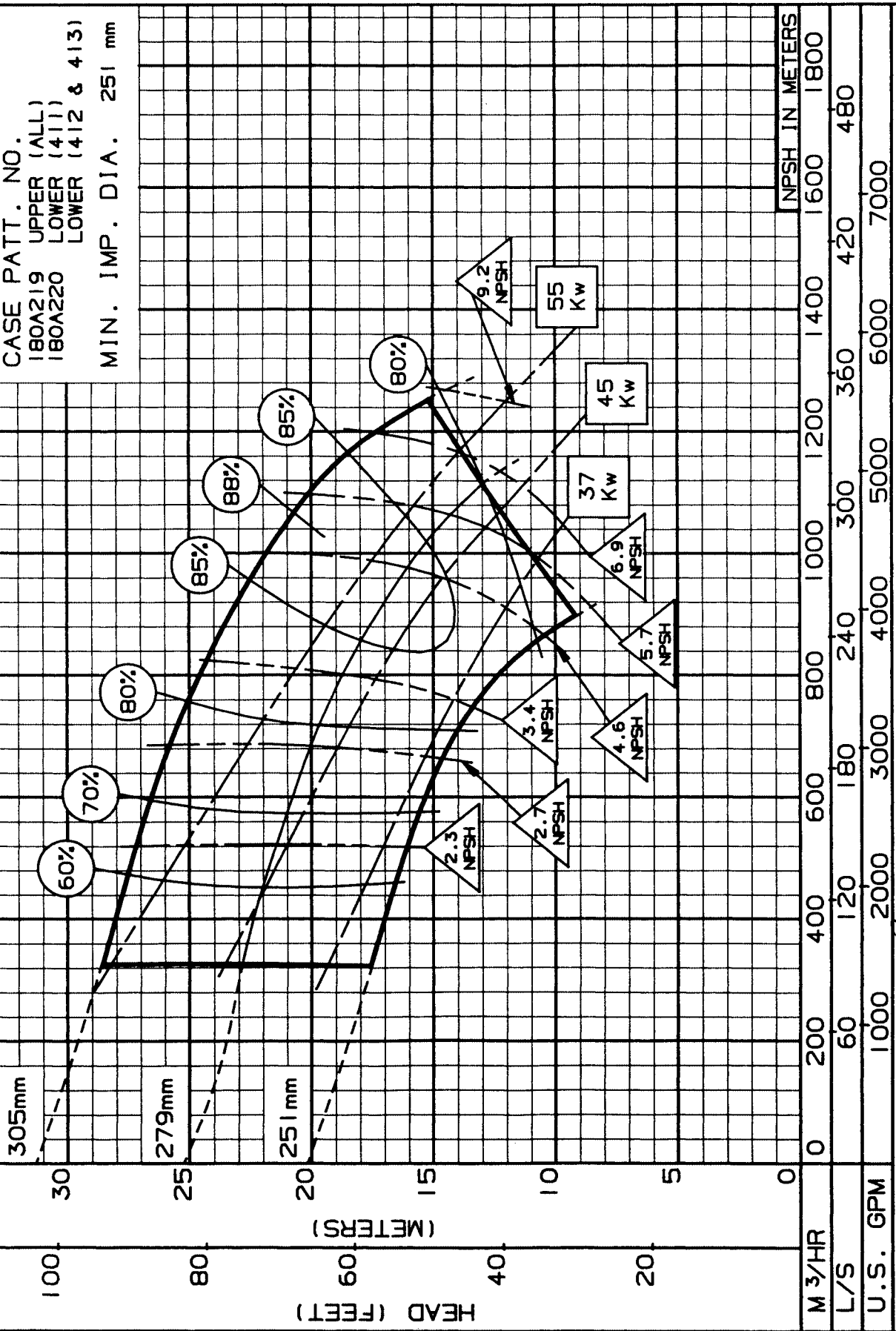

DRAWN BY: *[Signature]* APPROVED BY: DL DATE: 7-90 PC-117399M

SIZE: 10X12X12B TYPE: 410 IMPELLER: ENCLOSED R.P.M.: 980

MAX. SPHERES 24 mm
IMP. PATT. NO. 444A144
CASE PATT. NO.
180A219 UPPER (ALL)
180A220 LOWER (411)
LOWER (412 & 413)
MIN. IMP. DIA. 251 mm

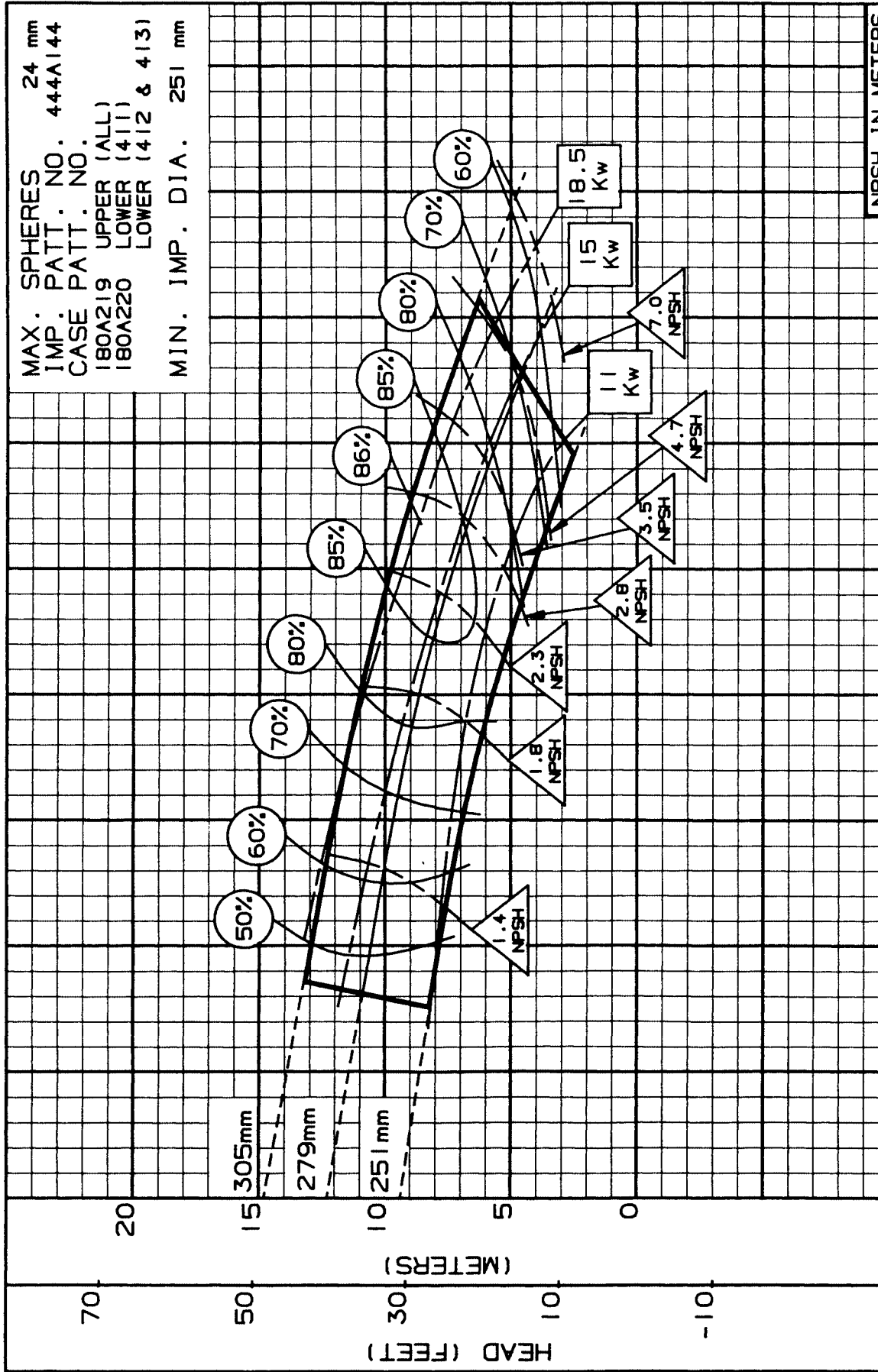

M ³ /HR	0	125	250	375	500	625	750	875	1000	1125
L/S	40	600	1200	1800	2400	3000	3600	4200	4800	5400
U.S. GPM	600	1200	1800	2400	3000	3600	4200	4800	5400	6000
NPSH IN METERS										

DRAWN BY: *RAN* APPROVED BY: *DL* DATE: 7-90 PC-117400M

SIZE: 10X12X15B TYPE: 410 IMPELLER: ENCLOSED R.P.M.: 1475

MAX. SPHERES 36 mm
 IMP. PATT. NO. 444A145
 CASE PATT. NO.
 180A221 UPPER (ALL)
 180A222 LOWER (411)
 LOWER (412 & 413)
 MIN. IMP. DIA. 305 mm

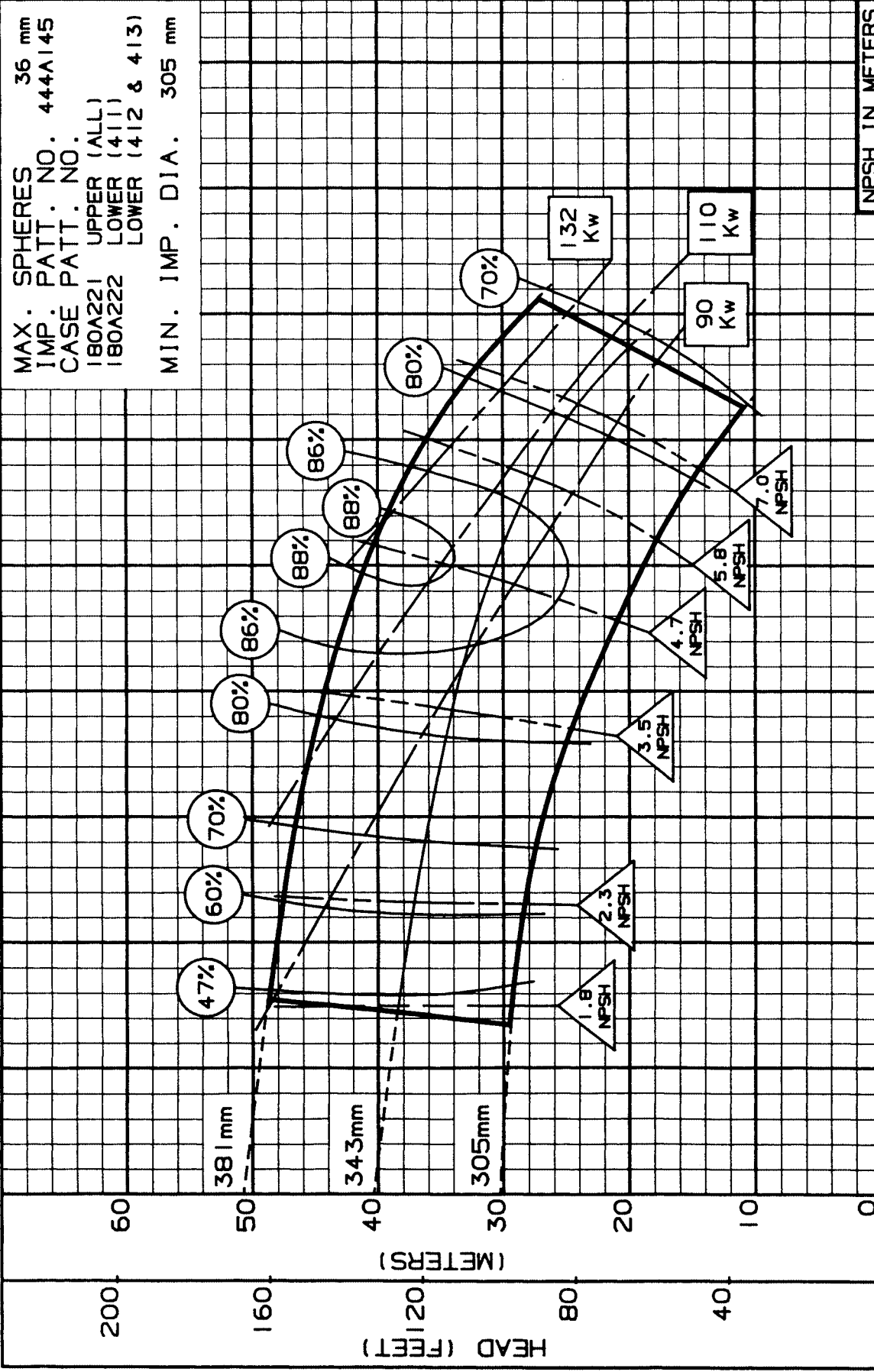

M ³ /HR	0	200	400	600	800	1000	1200	1400	1600	1800
L/S	0	60	120	180	240	300	360	420	480	
U.S. GPM	0	1000	2000	3000	4000	5000	6000	7000		
DRAWN BY: <i>[Signature]</i> APPROVED BY: DL DATE: 7-90										
PC-117401M										

SIZE: 10X12X15B TYPE: 410 IMPELLER: ENCLOSED R.P.M.: 980

MAX. SPHERES 36 mm
IMP. PATT. NO. 444A145
CASE PATT. NO.
180A221 UPPER (ALL)
180A222 LOWER (411)
LOWER (412 & 413)
MIN. IMP. DIA. 305 mm

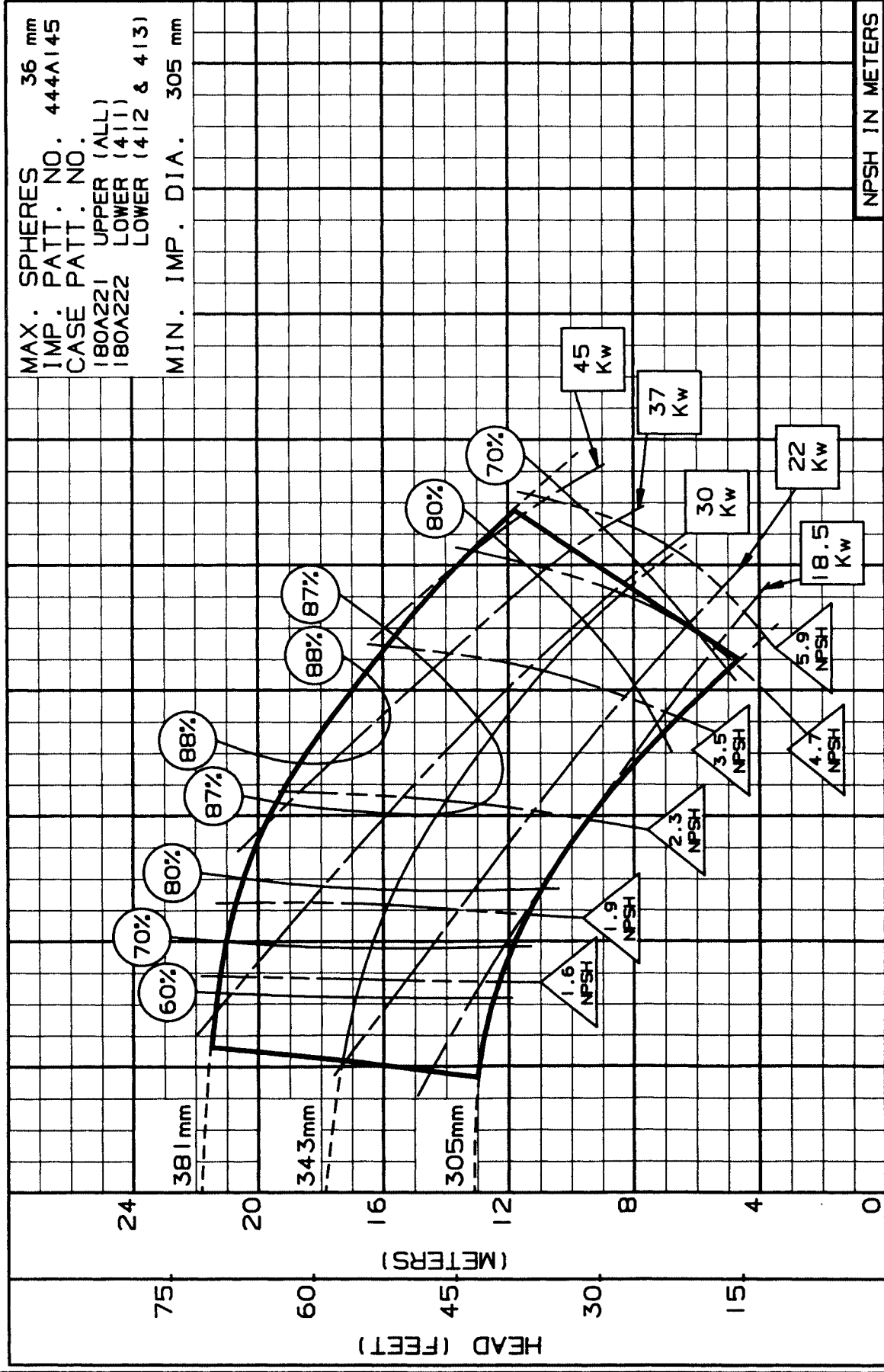

M ³ /HR	0	200	400	600	800	1000	1200	1400	1600	1800
L/S	0	60	120	180	240	300	360	420	480	
U.S. GPM	0	1000	2000	3000	4000	5000	6000	7000		
NPSH IN METERS										

DRAWN BY: *[Signature]* APPROVED BY: *[Signature]* DATE: 7-90 PC-117402M

SIZE: 10X12X15C TYPE: 410 IMPELLER: ENCLOSED R.P.M.: 1475

MAX. SPHERES 29 mm
 IMP. PATT. NO. 4340
 CASE PATT. NO.
 180A221 UPPER (ALL)
 180A222 LOWER (411)
 LOWER (412 & 413)
 MIN. IMP. DIA. 318 mm

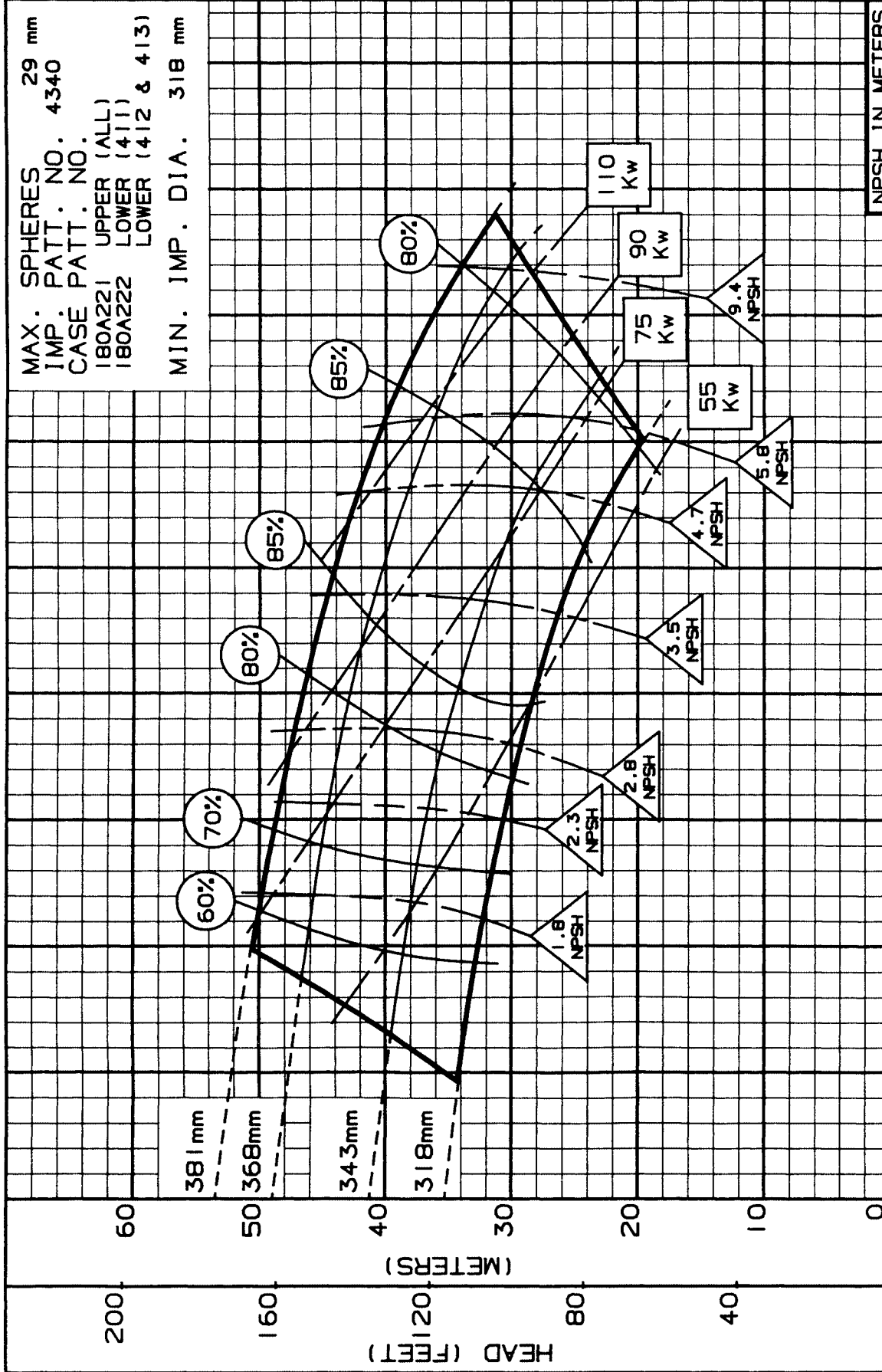

M ³ /HR	0	150	300	450	600	750	900	1050	1200	1350
L/S	0	50	100	150	200	250	300	350	400	450
U.S. GPM	0	750	1500	2250	3000	3750	4500	5250	6000	6750

DRAWN BY: *APC* APPROVED BY: *bt* DATE: 7-90 PC-125182M

SIZE: 10X12X15C TYPE: 410 IMPELLER: ENCLOSED R.P.M.: 980

MAX. SPHERES 29 mm
IMP. PATT. NO. 4340
CASE PATT. NO.
180A221 UPPER (ALL)
180A222 LOWER (411)
LOWER (412 & 413)
MIN. IMP. DIA. 318 mm

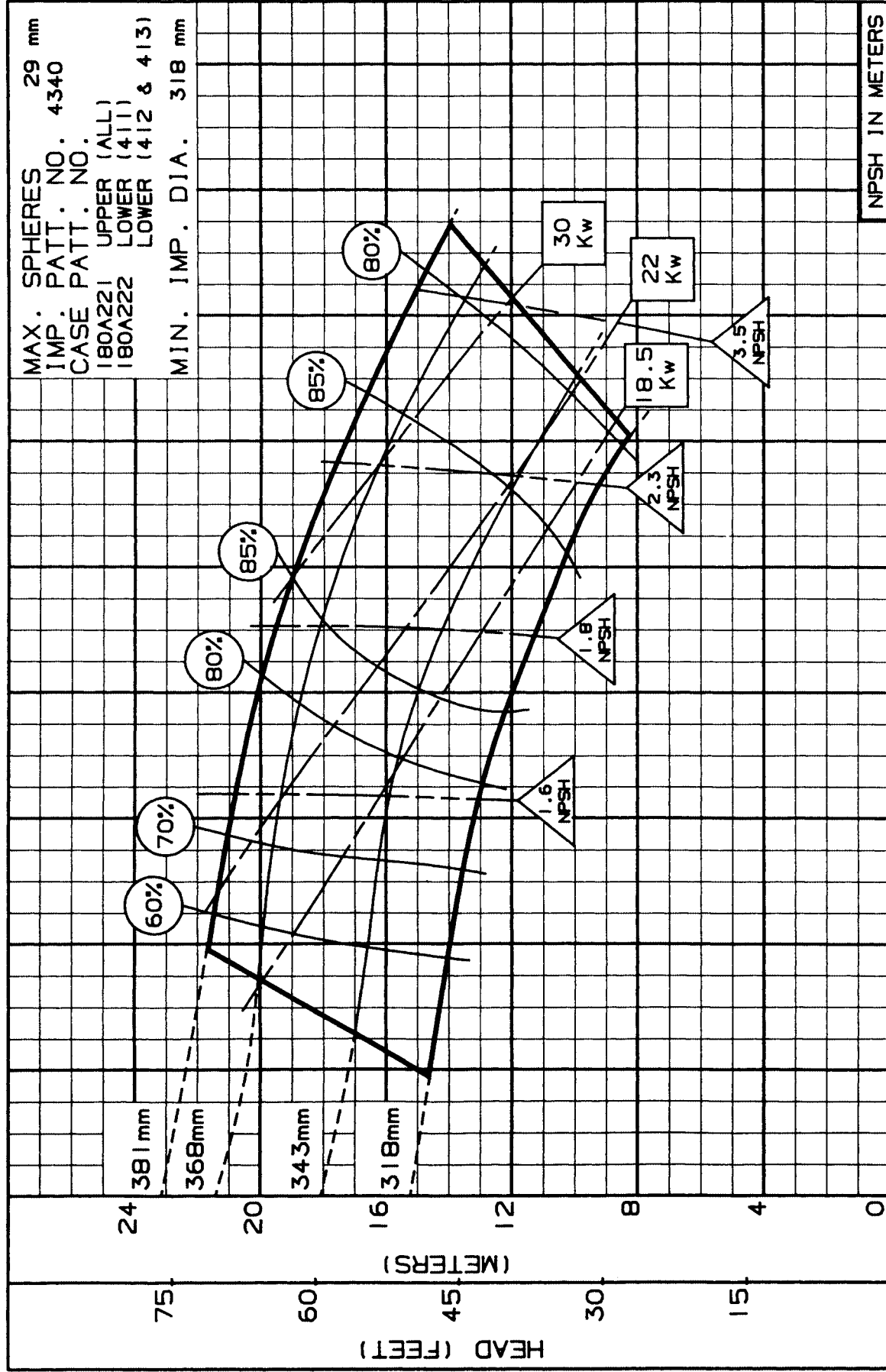

M ³ /HR	0	100	200	300	400	500	600	700	800	900
L/S	40	160	320	480	640	800	960	1120	1280	1440
U.S. GPM	500	1000	1500	2000	2500	3000	3500	4000	4500	5000

DRAWN BY: *DL* APPROVED BY: *DL* DATE: 7-94 PC-1251B1M

10x12x18 - 1475 RPM

ENCLOSED IMPELLER



Pentair Pump Group

SIZE: 10X12X18 TYPE: 410 IMPELLER: ENCLOSED R.P.M.: 1475

MAX. SPHERES 40 mm
 IMP. PATT. NO. 444A146
 CASE PATT. NO.
 180A223 UPPER (ALL)
 180A224 LOWER (411)
 LOWER (412 & 413)
 MIN. IMP. DIA. 381 mm

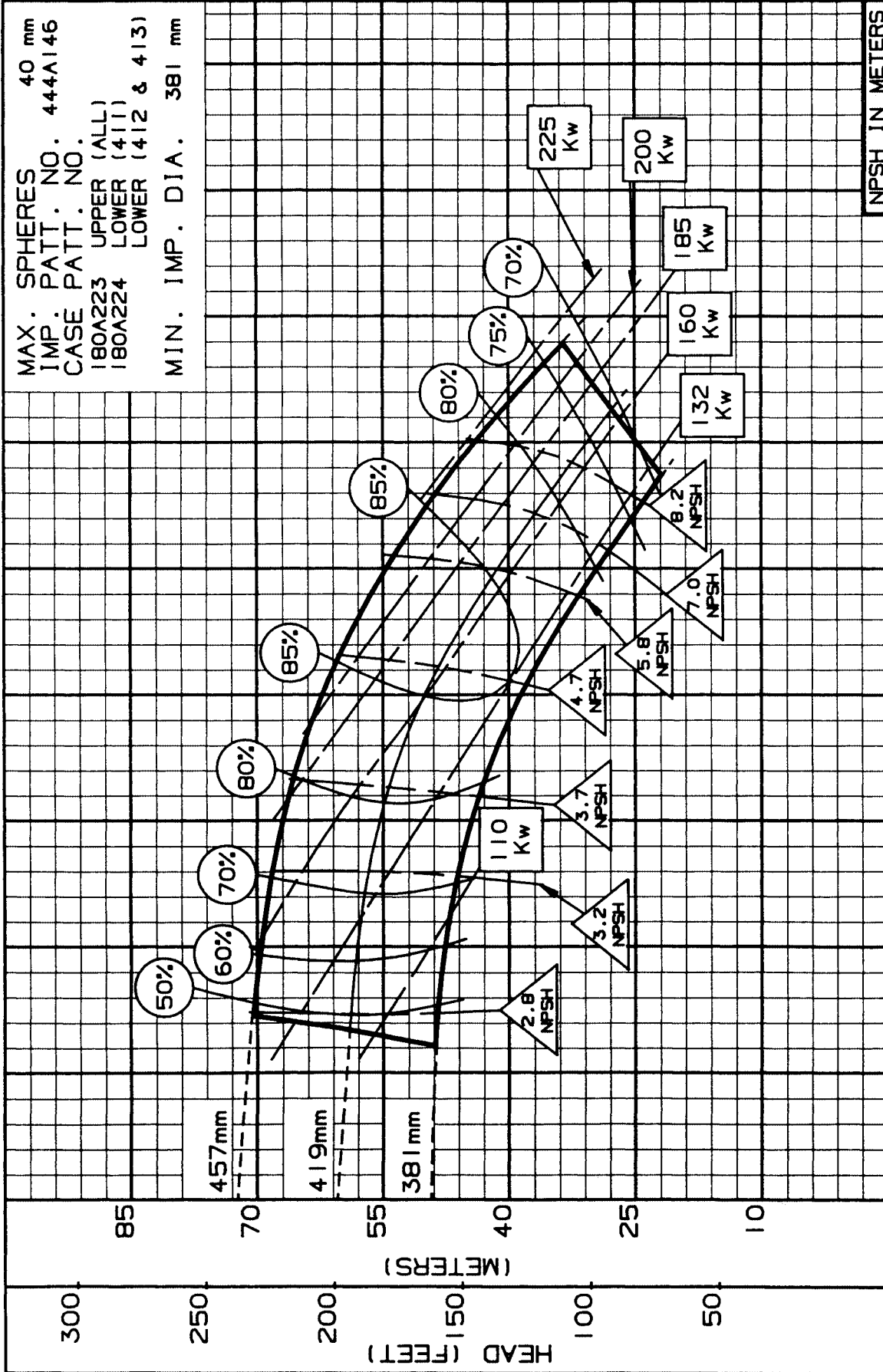

M ³ /HR	0	250	75	150	300	450	600	750	900	1000	1250	1500	1750	2000	2250
L/S															
U.S. GPM	1500	3000	4500	6000	7500	9000	600	525	450	375	300	225	150	75	0

DRAWN BY: *RAH* APPROVED BY: DL DATE: 7-90 PC-117403M

SIZE: 10X12X18 TYPE: 410 IMPELLER: ENCLOSED R.P.M.: 980

MAX. SPHERES 40 mm
IMP. PATT. NO. 444A146
CASE PATT. NO.
180A223 UPPER (ALL)
180A224 LOWER (411)
LOWER (412 & 413)
MIN. IMP. DIA. 381 mm

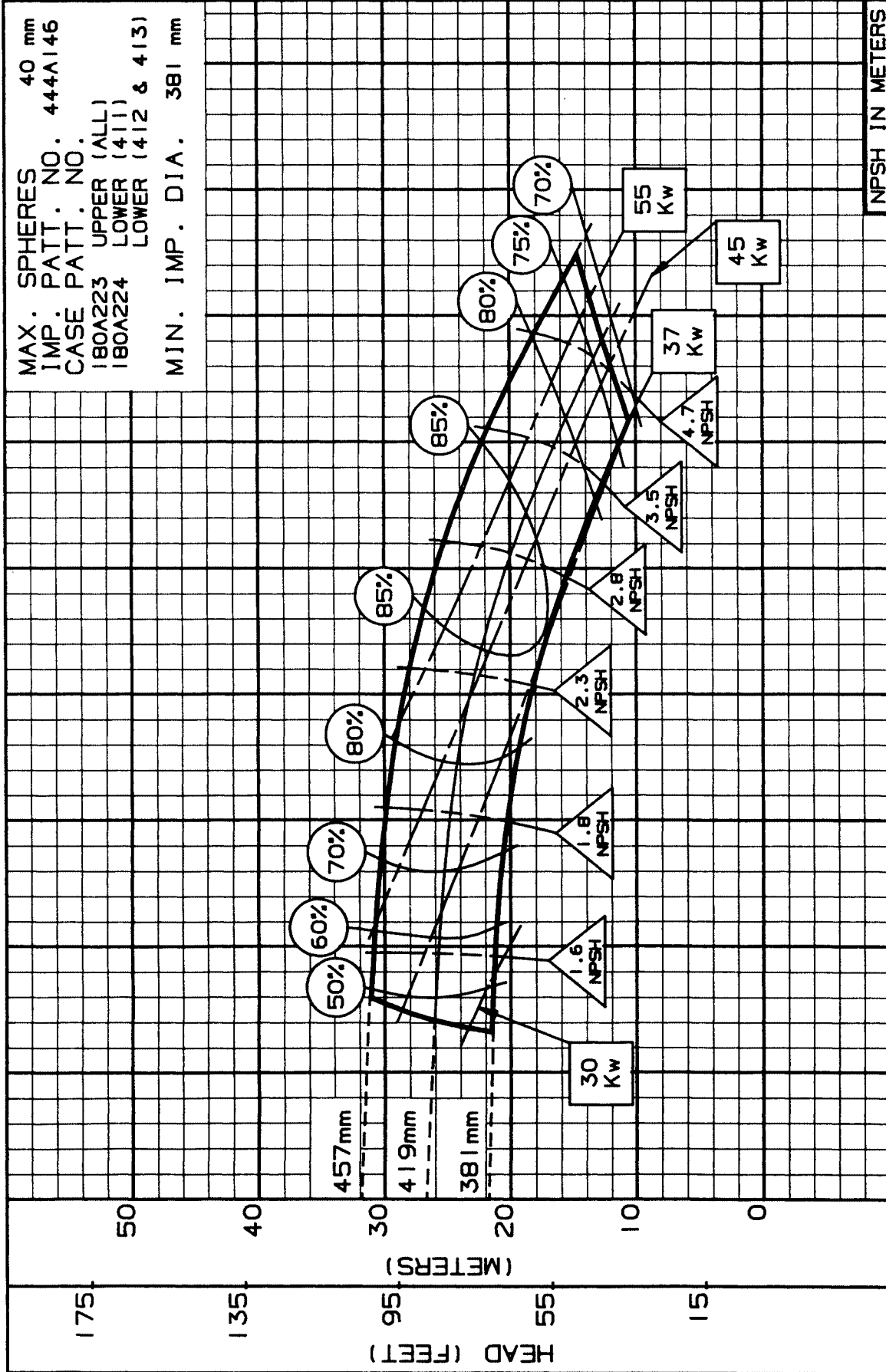

M ³ /HR	0	150	300	450	600	750	900	1050	1200	1350
L/S	0	50	100	150	200	250	300	350	400	450
U.S. GPM	0	750	1500	2250	3000	3750	4500	5250	6000	6750

DRAWN BY: *BAK* APPROVED BY: DL DATE: 7-94 PC-117404M

12x14x15B - 1475 RPM
 ENCLOSED IMPELLER



SIZE: 12X14X15B TYPE: 410 IMPELLER: ENCLOSED R.P.M.: 1475

MAX. SPHERES 27 mm
 IMP. PATT. NO. 444A147
 CASE PATT. NO.
 180A225 UPPER (ALL)
 180A226 LOWER (411)
 LOWER (412 & 413)
 MIN. IMP. DIA. 305 mm

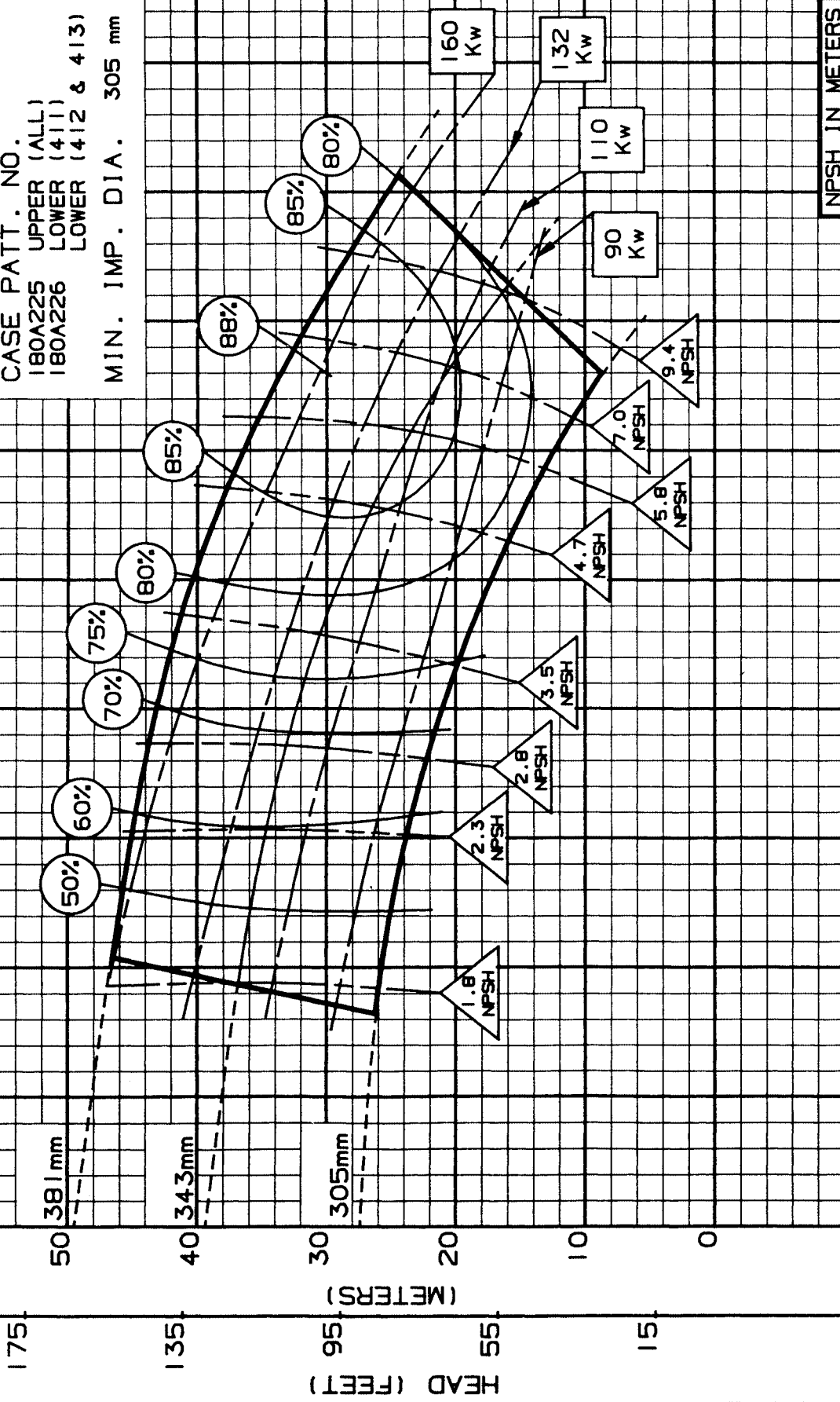

M ³ /HR	0	250	500	750	1000	1250	1500	1750	2000	2250
L/S	75	150	225	300	375	450	525	600	675	750
U.S. GPM	150	300	450	600	750	900	1050	1200	1350	1500

NPSH IN METERS
 0 250 500 750 1000 1250 1500 1750 2000 2250

DRAWN BY: *MLC* APPROVED BY: DL DATE: 7-90
 PC-132822M

SIZE: 12X14X15B TYPE: 410 IMPELLER: ENCLOSED R.P.M.: 980

MAX. SPHERES 27 mm
IMP. PATT. NO. 444A147
CASE PATT. NO. 180A225 UPPER (ALL)
180A226 LOWER (411)
MIN. IMP. DIA. 305 mm

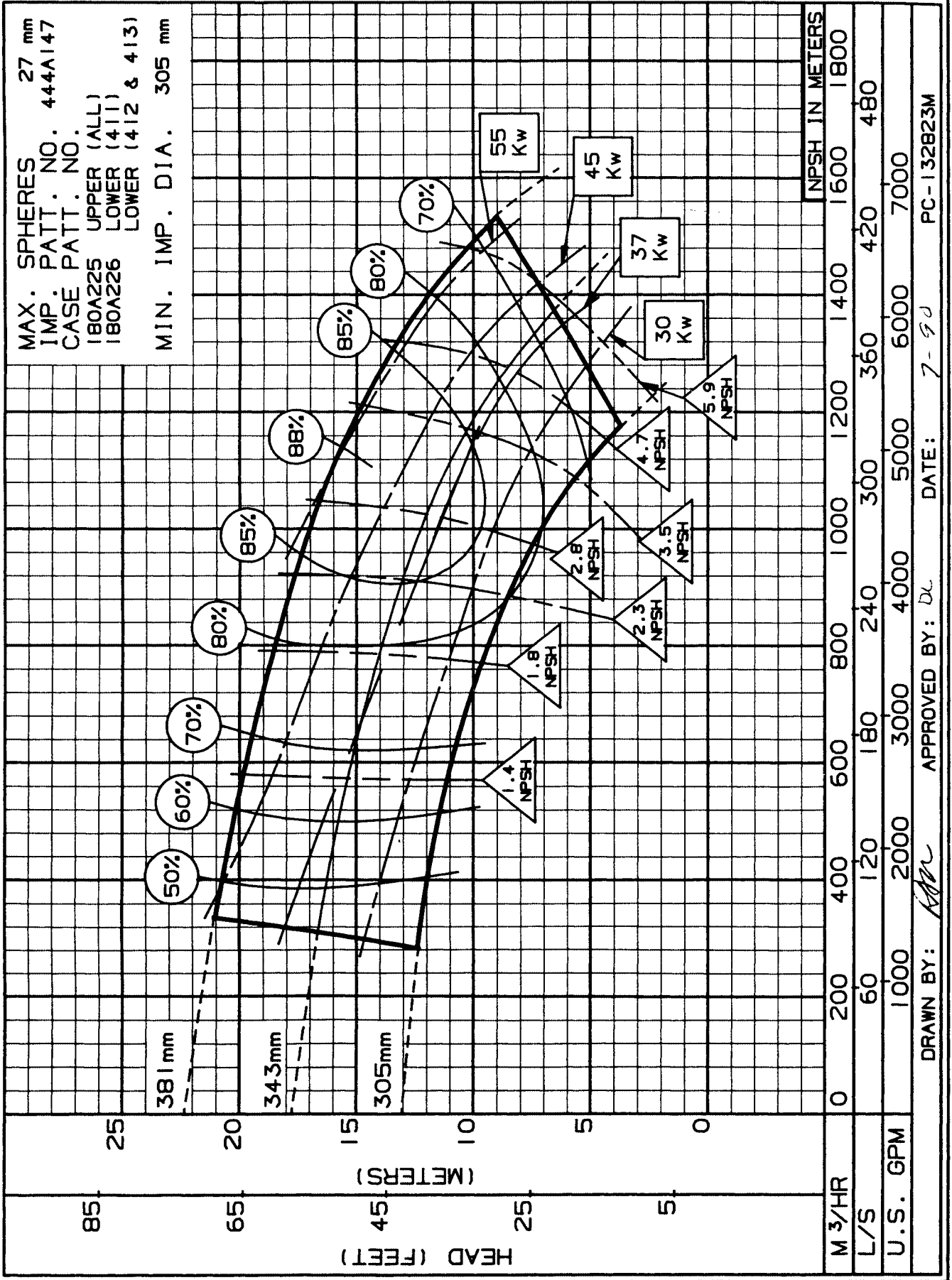

DRAWN BY: *[Signature]* APPROVED BY: *[Signature]* DATE: 7-94 PC-132B23M

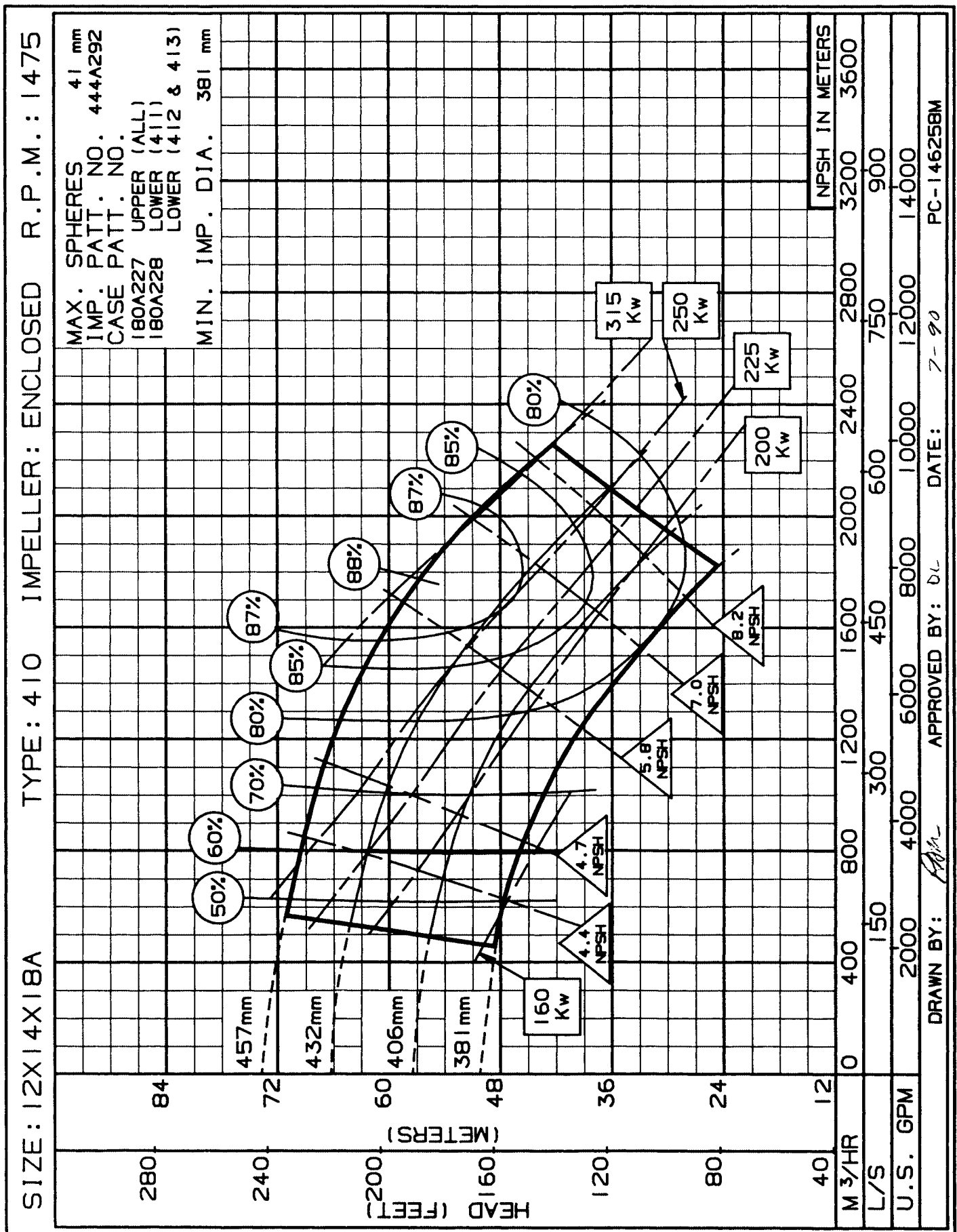

SIZE: 12X14X18A TYPE: 410 IMPELLER: ENCLOSED R.P.M.: 980

MAX. SPHERES 41 mm
IMP. PATT. NO. 444A292
CASE PATT. NO. 180A227 UPPER (ALL)
180A228 LOWER (411)
LOWER (412 & 413)
MIN. IMP. DIA. 381 mm

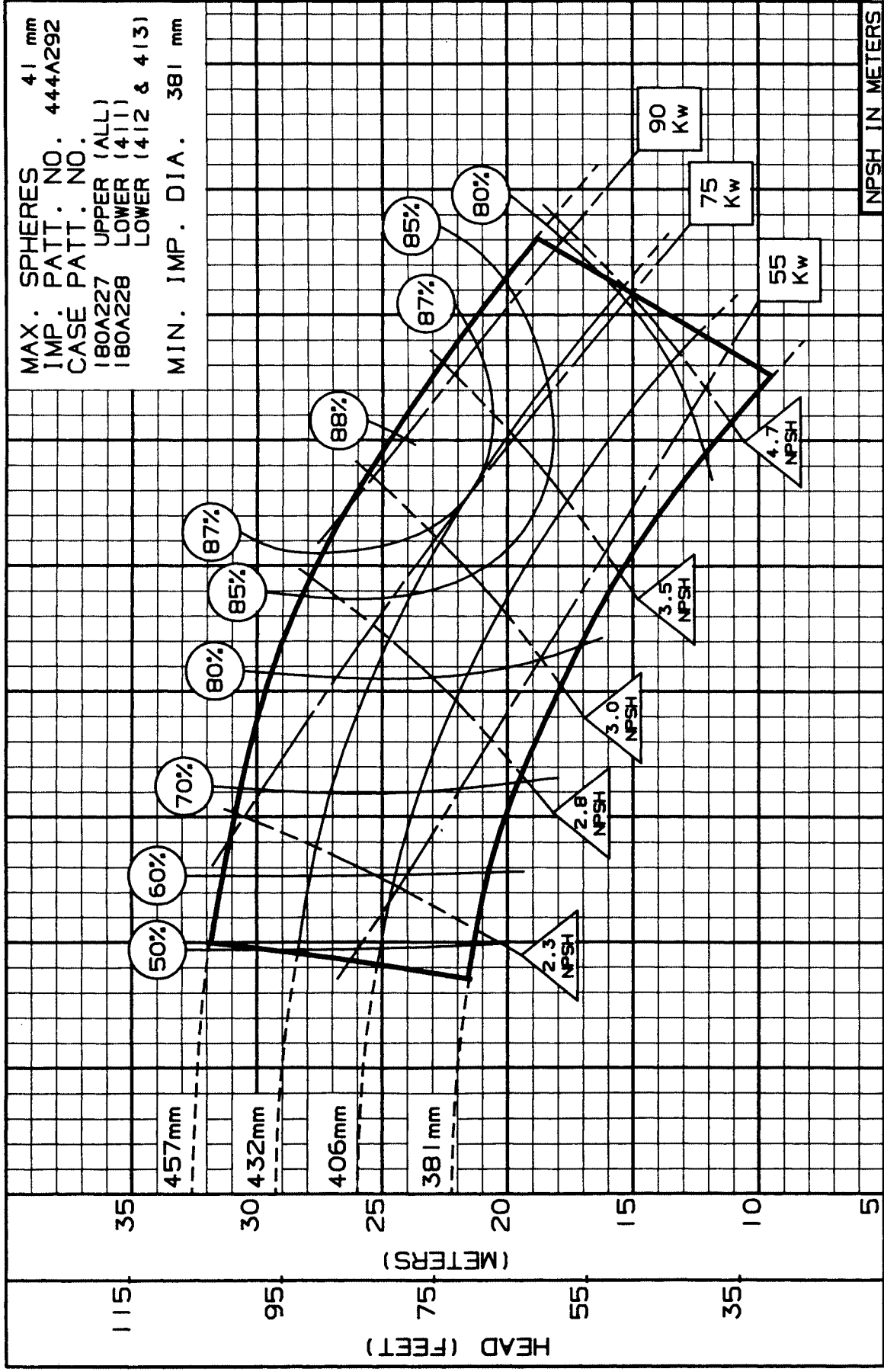

M ³ /HR	0	200	400	600	800	1000	1200	1400	1600	1800
L/S	60	120	180	240	300	360	420	480	540	600
U.S. GPM	1000	2000	3000	4000	5000	6000	7000	8000	9000	10000

DRAWN BY: *Boyl* APPROVED BY: DL DATE: 7-90 PC-146257M

SIZE: 14X16X18 TYPE: 410 IMPELLER: ENCLOSED R.P.M.: 980

MAX. SPHERES 38 mm
 IMP. PATT. NO. 444A149
 CASE PATT. NO.
 180A229 UPPER (ALL)
 180A230 LOWER (411)
 LOWER (412 & 413)
 MIN. IMP. DIA. 381 mm

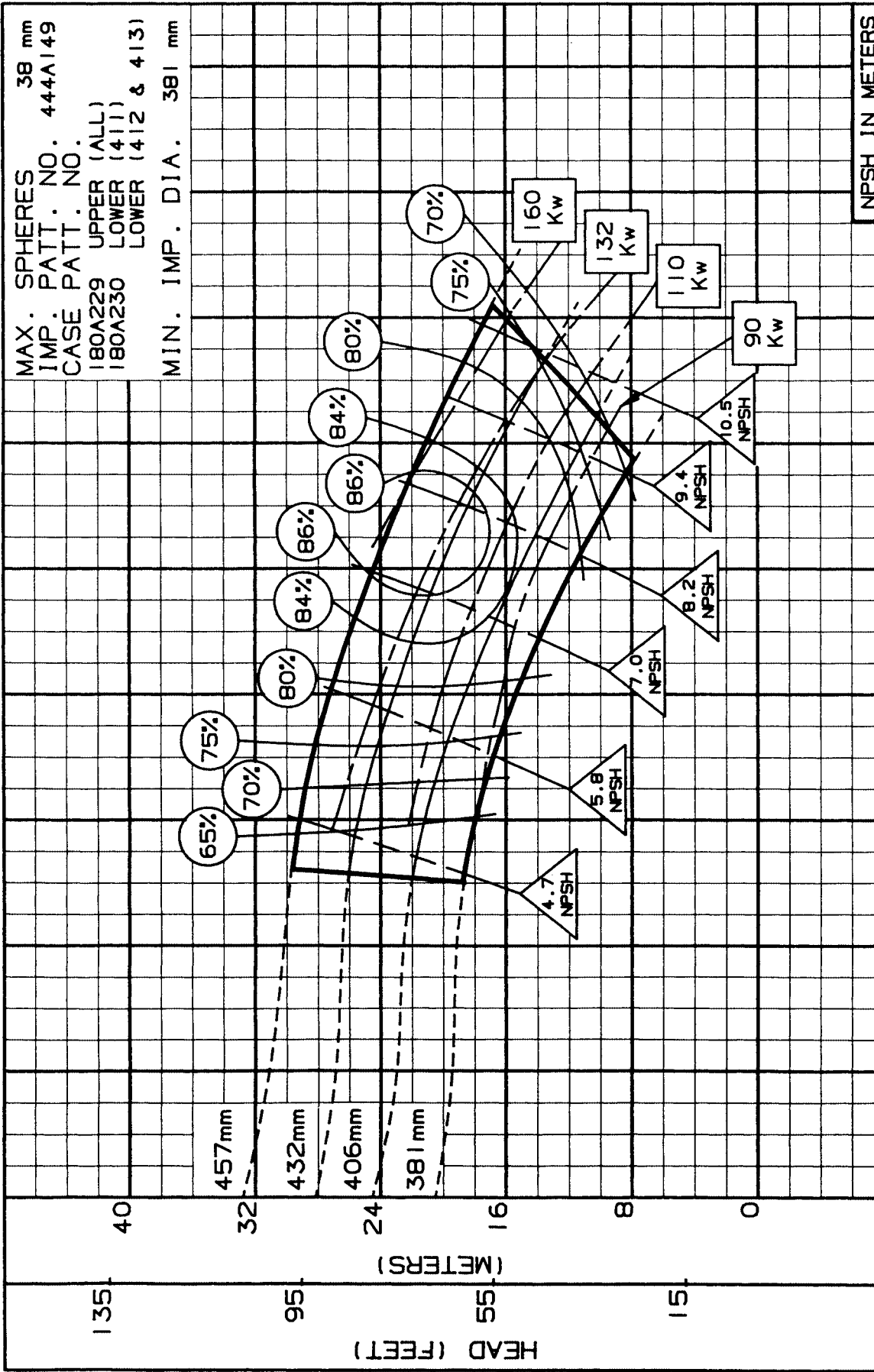

M ³ /HR	0	400	800	1200	1600	2000	2400	2800	3200	3600
L/S	150	300	450	600	750	900	1050	1200	1350	1500
U.S. GPM	2000	4000	6000	8000	10000	12000	14000	16000	18000	20000

DRAWN BY: *RDC* APPROVED BY: *DL* DATE: 7-90 PC-132250M

SIZE: 14X16X18 TYPE: 410 IMPELLER: ENCLOSED R.P.M.: 735

MAX. SPHERES 38 mm
IMP. PATT. NO. 444A149
CASE PATT. NO.
180A229 UPPER (ALL)
180A230 LOWER (411)
LOWER (412 & 413)
MIN. IMP. DIA. 381 mm

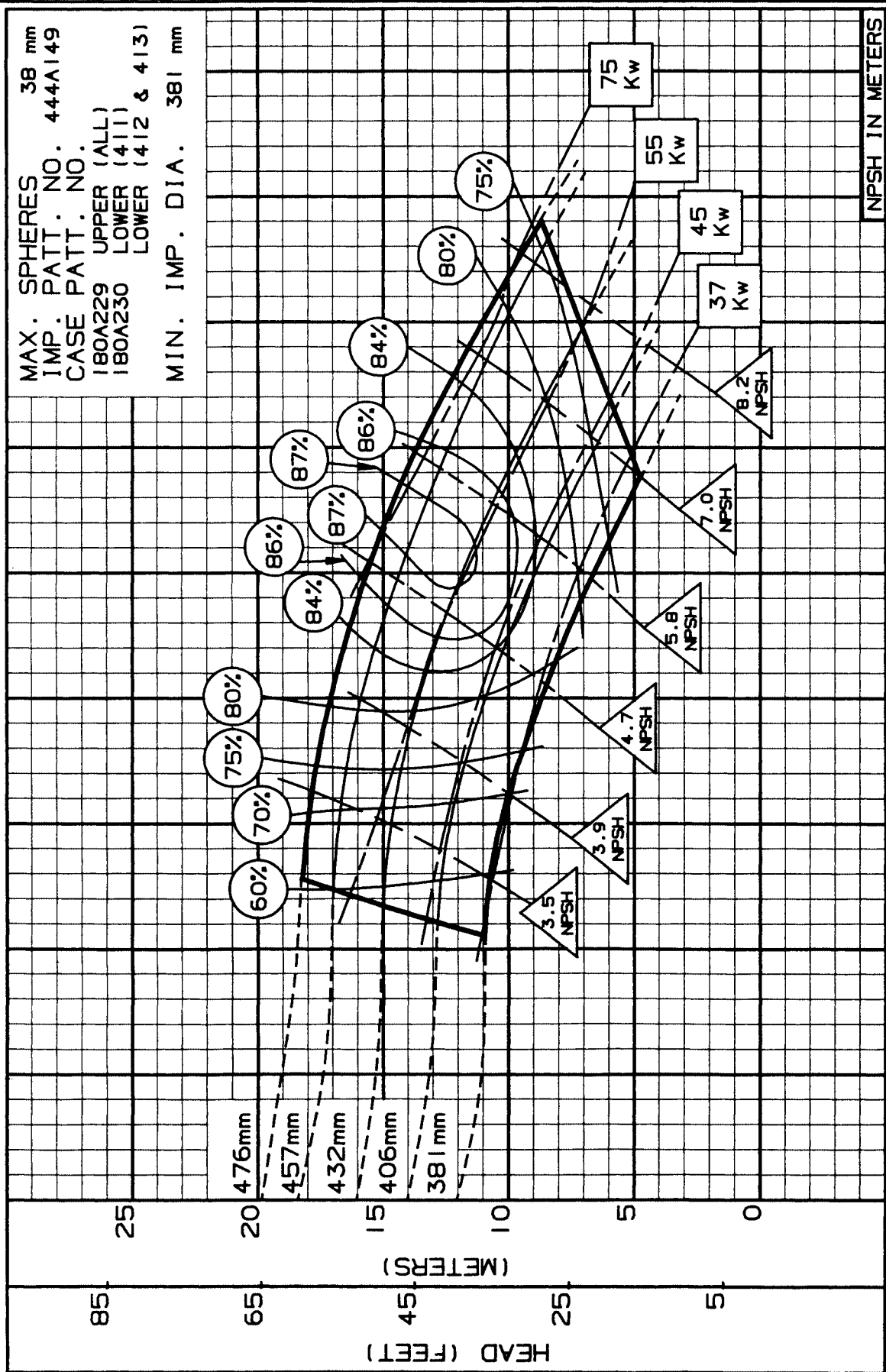

M ³ /HR	0	300	600	900	1200	1500	1800	2100	2400	2700
L/S	1500	3000	4500	6000	7500	9000	10500	12000	13500	15000
U.S. GPM	1500	3000	4500	6000	7500	9000	10500	12000	13500	15000

DRAWN BY: *RAM* APPROVED BY: *DL* DATE: 7-90 PC-132251M